

elektor

up-to-date electronics for lab and leisure

D 71683

87|88

July|August 1982

130 p.

IR 197 p. (incl. VAT)

CAN \$4.95

Sumide Szeg

**summer
circuits '82
more than 100
practical projects**

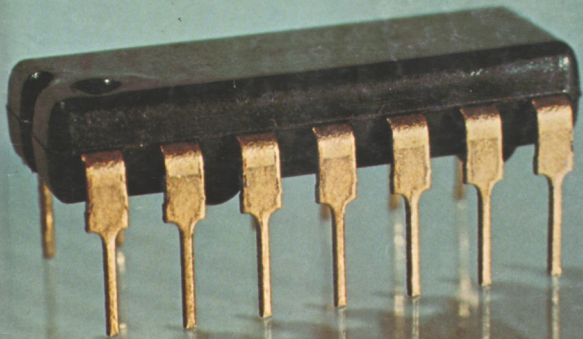



contents

Suunders Singh

1	light sensitive switch	7-14	54	a 'MID-FI' receiver	7-52
2	DC motor speed control	7-15	55	low cost temperature indicator	7-53
3	polystyrene cutter	7-16	56	duty cycle meter	7-53
4	summer circuits power supply	7-17	57	AC motor control	7-54
5	simple AGC	7-18	58	pulse generator	7-55
6	high voltage converter	7-18	59	oscilloscope aid	7-56
7	slave flash trigger - G. Kleinnibbelink	7-19	60	mini EPROMmer	7-57
8	temperature to frequency converter	7-19	61	5 V super power supply	7-58
9	frequency generator	7-20	62	short wave converter	7-59
10	signal strength meter	7-21	63	a simple window comparator	7-60
11	inverter oscillator	7-21	64	symmetrical opamp supply - J. Wallaert	7-60
12	serial keyboard interface	7-22	65	monoflop with a CMOS gate	7-61
13	RF amplifier for the 10 metre amateur band	7-22	66	electronic thermometer	7-61
14	active attenuator	7-23	67	fluid level detector	7-62
15	executive decision maker	7-24	68	voltage controlled waveform generator	7-62
16	automatic outdoor light - J. Bodewes	7-25	69	economical battery tester	7-63
17	slave flash - G. König	7-26	70	telephone bell	7-64
18	555 pulse generator	7-27	71	CMOS switch Schmitt-trigger	7-64
19	pushbutton interface - J. Ritchie	7-27	72	universal VCF	7-65
20	true RMS converter	7-28	73	keyless lock	7-66
21	miniature amplifier	7-28	74	digital logarithmic sweep generator - J. Meijer	7-67
22	OTA Schmitt-trigger	7-29	75	car lock defroster	7-68
23	TRS 80 cassette interface rediscovered	7-30	76	LED tuning indicator	7-69
24	mixing console	7-31	77	calling Junior vectors - R. Matussek	7-69
25	low voltage stabiliser	7-31	78	RTTY converter	7-70
26	overvoltage protection for meters	7-32	79	single cycle mode for the Junior Computer - E. Kytzia	7-71
27	stable amplitude low frequency oscillator	7-32	80	super low noise pre-amp	7-72
28	positive triangular waveform generator - R. Storn	7-33	81	crystal oscillator	7-73
29	smoke detector	7-34	82	infra-red remote control receiver	7-74
30	reciprocal amplifier	7-34	83	voltage controlled TTL oscillator - N. Rohde	7-75
31	blinky - J. Meijer	7-35	84	RS232 interface	7-76
32	double alarm - M. Prins	7-36	85	magic running lights	7-76
33	automatic delay switch - M. Prins	7-36	86	stable start/stop oscillator	7-77
34	dynamic RAM for SC/MP - D. Paulsen	7-37	87	sound effects generator	7-78
35	economical crystal time base	7-38	88	VCOTA	7-80
36	FET field strength meter	7-38	89	biomedical interface	7-80
37	automatic switch... for output amplifiers - W. Wehl	7-39	90	dissipation limiter - H. Bürke	7-81
38	mini high performance voltage regulator	7-40	91	stereo power amplifier	7-82
39	digital timer	7-40	92	power failure protection	7-83
40	converter for varicaps	7-41	93	12 dB VCF	7-84
41	low octave switch	7-42	94	voltage controlled filter	7-84
42	program EPROM	7-42	95	simple frequency converter - R. van den Brink	7-85
43	infra-red remote control transmitter	7-43	96	high performance video mixer	7-86
44	high-speed NiCad charger	7-44	97	rear light monitor	7-86
45	logic probe	7-45	98	connection tester - P. Verhoosel	7-87
46	high quality tape playback pre-amp	7-46	99	AC/DC converter	7-88
47	square triangle VCO	7-47	100	high speed printer routine - F. de Bruijn	7-89
48	graphic oscillator	7-48	101	phase sequence indicator - F. op 't Eynde	7-89
49	analogue monoflop	7-48	102	the Elekterminal with a printer - E. François	7-91
50	the simplest PDM amplifier	7-49			
51	class AB amplifier	7-50			
52	omnivore LED	7-51			
53	EX(N)OR opamp - A. Rochat	7-51			

We regret to inform readers that the technical queries telephone service will not be operating during the months of July and August.



our apologies

this isn't Elektor!

. . . no matter what it says on the cover.

Each year, we produce ten issues of Elektor: January to June, and September to December. For July and August, we print something completely different: the Summer Circuits issue!

It's not really a magazine, because there are too many circuits and too many pages. But it's not really a book, either, mainly because the size is wrong (although lots of people use it as a kind of quick reference book for new circuit ideas). So what? As one philosophically-minded genius proclaimed, after several hours of deep and profound thought: "It is what it is".

Even if we don't know what it is, at least we know what to put into it: 'more than 100 circuits'. Each year, we try to do better than the year before. Last year we stated, truthfully, that 'nearly all circuits have been built and tested' — the exception being a few simple application notes and some straightforward ideas from external authors. This year, we built and tested the lot!

Although . . . no, that's not quite true. Another of our traditions is to include one 'joke circuit'. Last year (for the few readers who didn't spot it!) we published a solar-powered torch. This year . . . no, work it out yourself. We can give one clue: we think the circuit should work, but we can't see how to actually test it in the situation for which it is intended.

Tradition and progress. This issue is 'traditional' — we've been doing it for years — and the quality and diversity of the circuits is even better than last year (we think), so that's 'progress'. Next year, maybe, we'll try to make the text better: cram even more valid information into the number of lines available. Maybe even improve the grammar? You never know: ten years from now this issue may be required reading for 'Arts' students.

So, what's new? An 'editorial introduction', in the best tradition (and that eliminates a large number of editorial introductions . . .) should contain something more than light reading. Let me think . . . we must have something . . . Electronics in the future? Difficult . . . we try to convert our futuristic ideas into something practical, and simply publish it as a circuit. Next month's ideas, maybe? No let's surprise our readers with that dark-room computer, way-out hifi system and 16-bit-microcomputer . . . Talking about computers, there's one point: 'hardware', 'software' and even 'firmware' are known — but have you ever heard of 'paperware'? No?! Well then, that's new! Take a look on page 90.

What else? Oh yes! I almost forgot. Our front panels! We've had a 'front panel service' for quite some time, but it never really satisfied us. Either a panel is expensive, or else you can see that it is not so expensive. Now — at last! — we think we've solved it. Professional front panels at a price that came as a pleasant surprise to us. As a first shot, we've got a panel for the Elektor 'Artist'. If that one works out as we expect, our 'printed circuit board service' may well become a relatively traditional side-line. The new 'front panel service' could well lick it hollow, as regards 'uniqueness' (or should that be 'uniquity' or 'unicitude'? As stated earlier, grammar is scheduled ten years from now.).

Now — forgive me! — I intend to stop. There's a hot soldering iron beside me, and I want to use it. That no-I-won't-tell-you-which circuit intrigues me . . .

Your editor.

1

light sensitive switch

a de-light-full circuit!

There is a wide range of applications for light sensitive switches: staircase light timers, outdoor illumination, automatic door openers by means of a light beam, alarm systems and so on. Many of our readers will be familiar with the single transistor opto-switch where a LDR is placed between the base and either ground or supply depending whether a 'normally on' or 'normally off' function is required.

This simple circuit gave way to more complex arrangements involving the use of opamps with the advent of the supercheap 741! Another, not so well-known, method of opto-detection uses a bridge circuit operating on the principle that current flow across the bridge will be zero when the four impedances have been calculated correctly. The 'bridge is in balance' when this occurs.

The latter principle is used in the circuit here. The opto-detector is situated in a bridge circuit and a comparator is used as a 'bridge is in balance' indicator. The comparator output fires a thyristor via a transistor. Caution must be used with this circuit, since it is not isolated from the mains supply.

Power to the circuit is derived via the bridge rectifier D1...D4 and is smoothed and stabilised by means of R1, C1 and D5. The bridge circuit may be difficult to see in the circuit diagram, but it consists of R2...R4, P1 and the light dependent resistor (LDR). IC1 is connected as comparator and its output voltage level will become approximately 1.8 V when the potential at the inverting (negative)

input exceeds that of the non-inverting input. Resistor R5 creates an 'hysteresis' of about 1 V to prevent T1 and the thyristor from switching 'on' and 'off' (flickering) in marginal light conditions. The switching point of the comparator is adjustable by means of P1. With this potentiometer set to minimum resistance, the lamp will switch on at twilight. Readers who require greater flexibility can replace P1 by a 1 M Ω type. The LDR can be

exchanged with the P1/R4 combination to provide the circuit with 'inverse law'. The lamp La1 will be extinguished at the onset of darkness. Some practical considerations: For switching higher power lamps D1...D4 must be replaced by 1N5404 types and a heat sink must be used for Th1. With these modifications the circuit will cater for current levels up to 3 amperes. The maximum gate current available for Th1 is 250 μ A, which means that a fairly 'sensitive' thyristor should be used.

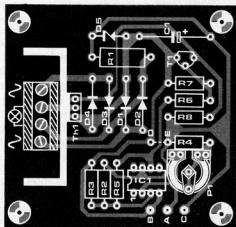
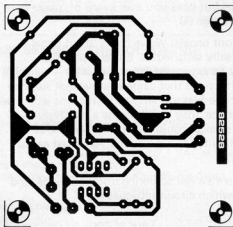
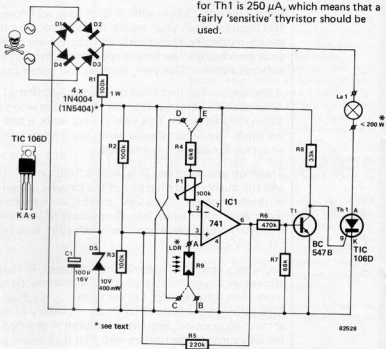

Parts list

Resistors:

R1 = 100 k/1 W
 R2, R3 = 100 k
 R4 = 6k8
 R5 = 220 k
 R6 = 470 k
 R7 = 68 k
 R8 = 33 k
 R9 = LDR 03, 05 or 07
 P1 = 100 k preset potentiometer

Capacitor:

C1 = 100 μ F 16 V

Semiconductors:

D1 ... D4 = 1N4004 (1N5404)
 D5 = zener diode 10 V/400 mW
 T1 = BC 547B
 IC1 = 741
 Th1 = TIC 106D

Any LDR should be suitable. There is no apology for repeating the cautions regarding the lack of isolation from the mains supply. With this in mind it is essential that the completed circuit is housed securely in some form of plastic box. A hole can be made in the top of the box for the LDR to 'see' through. Make sure that both the input and output cables are fitted securely. These precautions will ensure that prying fingers will not come to grief.

2

DC motor speed control

with current feedback

The LM 1014 IC from National Semiconductor can be used to provide a constant speed control for small DC motors. A well known trick is used here. This takes into consideration the fact that when the motor current rises (due to an increase in load) the voltage across the motor will follow suit. The reason for this is that if the motor speed drops slightly the back EMF decreases which means that the motor current (given the same supply voltage) is going to increase. It follows that raising the voltage across the motor will increase the speed. Theoretically then, it is possible to hold the motor speed virtually constant in this way.

However, in practice this system has a

Table

V _{ref} (V)	$\Delta V_{ref}/\Delta T$ (mV/°C)	Condition
0.95	-1.0	2/3 open
1.15	-0.3	2 gnd, 3 open
1.35	+0.3	2 open, 3 gnd
1.55	+1.0	2/3 gnd

tendency to be unstable and the only way to keep it within acceptable limits is to allow slight speed variations in the order of a few percent (depending on load conditions).

A disadvantage of the circuit is that the value of the components required cannot be given as hard and fast. It is a circuit then that does require some experimenting with in order to obtain the best results. The values of resistors

R1, R2 and R3 should be selected so that $\frac{R1 \cdot R3}{5R2}$ is equal to the dynamic impedance of the motor. How do you find this? A good start for the calculation is to simply measure the resistance of the motor with a multi-meter and start with this value. Choose R1 to be slightly on the low side from the formula and check whether or not the motor is still controllable. As long as it doesn't run wild (run up to maximum speed and stay there) or start hunting, R1 can be increased in value.

The output voltage, and with it the speed, can be adjusted by means of P1. The formula for the output voltage is given in the diagram. Before calculations are begun, a reference voltage must be selected via pins 2 and 3. Each reference voltage has a different temperature coefficient (see table).

This parameter of the motor will rarely be known and so the choice will come down to personal taste.

The value of P1 is not really critical. This potentiometer at minimum value will certainly give maximum volts supply but using too small a value will only render it impossible to slow the motor very much. The choice of R1 not only determines the dynamic characteristic of the circuit but also limits the maximum motor current. With the value shown in the diagram (1 Ω) the maximum current will be 1.4 A. The values given were actually used with a motor that was measured as follows:

Dynamic resistance: 16.3 Ω
 Reverse EMF: 3.25 V at 2000 rpm
 Torque: 5.9 mA per mmm

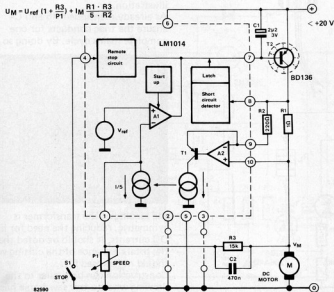

$$U_M = U_{ref} \left(1 + \frac{R_3}{P_1}\right) + I_M \frac{R_1 \cdot R_3}{5 \cdot R_2}$$

3

polystyrene cutter

hot wiring for beginners

Have you ever tried to cut polystyrene panels or blocks with a conventional saw? Messy is it not? Little bits of the stuff everywhere and you still have not achieved what you set out to do.

The only way to cut polystyrene efficiently is by the hot wire method. The wire has to be kept at just the right temperature otherwise it will either not cut or it will burn the material into horrible little black bits. A low voltage transformer delivering a reasonable current of approximately 2 A is sufficient for the circuit. By controlling the current flow through the wire the actual temperature can also be regulated. In order to reduce the consumption and power dissipation the current is switched on and off intermittently by a triac.

One side of the 'hot wire' (represented by RL) is connected directly to the secondary winding of the transformer. N1 and N2 ensure that the sine wave (A.C. voltage) supplied by the transformer is converted into a square wave. In order for this to happen the values of R2 and R3 are calculated so that N2 switches on and off in phase with the A.C. supply. The RC network R4, C2 differentiates the positive pulse, the internal clamping diode of N3 suppressing the negative pulse. N3 and its surrounding components

form a time switch which in turn controls the triac. The switching periods are determined by C3. This capacitor is charged by way of P1, and discharged by way of R5 and D3, to the output of N3. The charge and discharge levels of C3 are within the threshold levels of the Schmitt-trigger N3. It therefore follows that the

voltage across C3 will either be logic 1 or 0. With a logic 1, N3 receives a positive pulse from N2 resulting in a short negative pulse at its output. This triggers N4 and in turn T1, which switches on the triac. The RC network

2

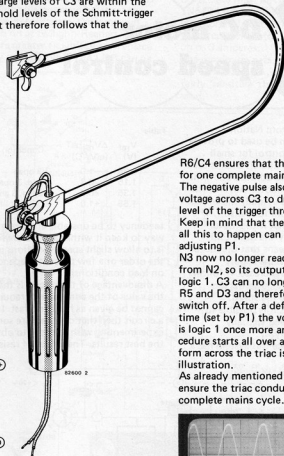

R6/C4 ensures that the triac conducts for one complete mains cycle.

The negative pulse also causes the voltage across C3 to drop below the level of the trigger threshold of N3. Keep in mind that the time frame for all this to happen can be varied, by adjusting P1.

N3 now no longer reacts to the pulses from N2, so its output remains at logic 1. C3 can no longer discharge via R5 and D3 and therefore the triac will switch off. After a defined period of time (set by P1) the voltage across C3 is logic 1 once more and the procedure starts all over again. The waveform across the triac is shown in the illustration.

As already mentioned R6 and C4 ensure the triac conducts for one complete mains cycle. By doing so

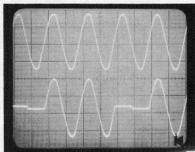

the loading of the transformer is symmetric, reducing the need for high DC currents. It should be noted that the total resistance of the cutting wire should not exceed 5 Ω.

Construction can be similar to the drawing where a fret saw frame has been used (with insulation!).

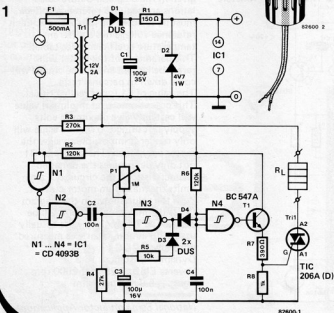

5

simple AGC

'LO-FI' but useful

This circuit will provide an output with a fairly constant amplitude of 4 V peak to peak, from an input that may vary between 100 mV to 2 V. There was no intention of achieving 'hi-fi' performance as the distortion figures are not exactly in that league.

Nevertheless, this automatic gain control is ideal for use when recording computer programs onto cassette tape where a constant amplitude is more important than low distortion. Opamp A1 provides an output impedance that is sufficiently low to

drive the attenuator formed by diodes D1 and D2. Opamp A2 is a straightforward amplifier with a gain of 100x but its DC setting is a little unusual in that it is derived from the average of the input signal via R5 and C4. The off-set voltage of A2 cannot escape being modified to some degree but, since this is relatively stable, it should not present too much of a problem. The output includes a peak detector consisting of D3 and C5. A proportion (determined by P1) of the voltage across C5 is passed back in the form of a feedback loop, via T1 and T2, to the D1/D2 attenuator. However, because the two transistors form a current source, it is the current through the two diodes that controls the gain of the final stage. In other words, an increase in the current across D1/D2 will result in a greater attenuation of the output.

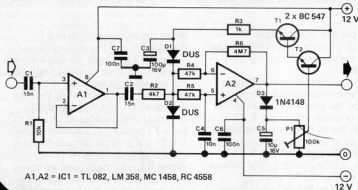

A1, A2 = IC1 = TL 082, LM 358, MC 1458, RC 4558

12 V

82962

6

high-voltage converter

a lab power supply from 0 ... 10000 V

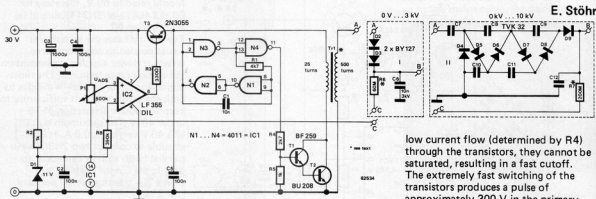

Given a 30 V power supply the circuit described can deliver a high voltage ranging from 0 to 3 kV (type 1), or from 0 ... 10 kV (type 2). N1 ... N3

are connected as an astable multi-vibrator (AMV), and drive the darlington configuration T1/T2 with a 20 kHz squarewave signal. Due to the

low current flow (determined by R4) through the transistors, they cannot be saturated, resulting in a fast cutoff. The extremely fast switching of the transistors produces a pulse of approximately 300 V in the primary winding of Tr1. This voltage is then stepped up in proportion to the number of secondary windings. The first version (type 1) of the circuit uses half-wave rectification. Type 2 is

E. Stöhr

* 88 1841

82534

simply a cascade rectifier out of an old T.V. set. Version 2 delivers a voltage three times higher than version 1 because the cascade rectifier acts as a voltage multiplier (3X).

IC2 regulates the output voltage. The opamp compares the voltage across P1 with that at the junction of the voltage dividers R6/R8 or R7/R8. If the output exceeds the preset voltage level, IC2 will reduce the supply voltage to the output via T3. The most important part of the circuit is the transformer.

Even though it is rather essential, its construction is not that critical.

A variety of E, EI or ferrite cores having a diameter of 30 mm can be used quite easily. The core should not have any air gap; an AL value of 2000 nH is about right. The primary winding consists of 25 turns of 0.7 mm ... 1 mm enamelled copper wire and the secondary is 500 turns of 0.2 ... 0.3 mm wire. The primary and secondary windings must be properly insulated from each other!

With respect to the high voltages the constructor should pay special attention to the following points:

- Capacitor C6 must be able to cope

with at least 3 kV.

- R6 in version 1 consists of six 10 MΩ resistors in series. R7 is made up by using 10 MΩ resistors, also in series. This is done in order to avoid spikes at the output.

Either circuit consumes approximately 50 mA without a load and 350 mA when delivering 2 ... 3 W into a load. Transistors T2 and T3 will require heat sinks.

7

slave flash trigger

using solar cells

A triggering circuit for slave flash guns ensures that the 'slave', flashes simultaneously with the main or master gun. Apart from the commercially available units, there are quite a few circuit designs published in electronic magazines. Unfortunately most of these have one major drawback. They all need some form of power supply, such as normal batteries etc. The circuit design described in this article uses a virtually in-exhaustible supply! Solar cells are applied here in an ingenious way! The flash of light emitted by the master gun will trigger the slave. The small delay which occurs is so small (in the order of 1/1000th of a second), that it is

virtually undetectable, by the human eye.

The circuit consists of a sensitive low powered thyristor, in this case the TIC 106D (Th1), and a choke. The solar cells (which should have a minimum surface area of 100 mm²) are connected in series. They generate the ignition pulse for the thyristor immediately the master flash is fired. A 68 mH choke ensures that the circuit is insensitive to ambient light. The prototype achieved an operating distance of 50 metres, between the slave and a master flash gun with a power figure of 28!

G. Kleinnibbelink

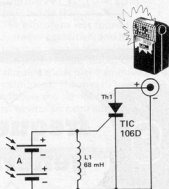

82569

8

temperature to frequency converter

°C into Hz

Although a temperature to voltage converter may be more common, a temperature to frequency converter is much more useful when digital circuits are used for temperature measurement. This type of converter can be connected to either a frequency counter or even a microprocessor, without the need for an additional A/D converter.

The circuit described here is remarkably accurate. A 10 Hz/°C conversion factor is maintained within 3 Hz, throughout the 5° to 100°C range.

A 'pseudo' zener diode, the temperature dependent LM 335, is used as the temperature sensor. The IC comes in a plastic transistor package. The ADJ pin is not used in this application. The

voltage across this 'zener diode' is directly related to the absolute temperature in degrees Kelvin:

$$U_{LM\ 335} = 10 \cdot T \text{ (mV)}$$

Therefore, at 0°C the voltage will be exactly 2.73 V. In order that the voltage to frequency converter can be calibrated in degrees centigrade, this

2.73 V input can be cancelled by an equal and opposite (negative) voltage. Instead of using a negative supply voltage for this, a little trick is employed. A +5 V regulator, IC3, boosts the GND connection of IC1 to +5 V with respect to supply common. The input offset can now be taken from preset P1. At the other end, the LM 335 is fed by the current source around T1. The output of the LM 331 (IC1) is a

square wave, swinging from +5 V (GND for this IC!) to positive supply. It is not difficult to relate this signal to the actual 0 V rail: two switching transistors, T2 and T3, take care of this level conversion.

T3 has an open collector output, so that it can easily be used to drive TTL or CMOS logic circuitry. Alternatively, frequency counters with an AC input can be connected direct to pin 3 of IC1 and T2 and T3 can be omitted.

To calibrate the circuit, a mixture of crushed ice and water gives a good 0°C reference. With the sensor in this slush, the voltage between the positive end of IC2 and pin 4 of IC1 (GND) can be set to 0 V by means of P1. A further reference is now required at approximately mid-scale — warm water at 50°C, as measured with a good thermometer. (Alternatively: approximately 37°C — there are very accurate thermometers in this range . . .). The output frequency is then set, with P2, to correspond: 370 Hz at 37°C, say.

For good temperature stability of the circuit, metal film resistors should be used for R5 . . . R7, and a polycarbonate capacitor for C4. Preferably, P1 and P2 should be Cermet helical potentiometers.

One final point. If the circuit is used to measure air temperature, this will invariably imply that the circuit itself will also be warmed up. In this case, the output may drift up to +0.5°C off mark. The solution is to . . . recalibrate the thermometer! Alternatively, try and keep the circuit as cool as possible, using plenty of heatsinks.

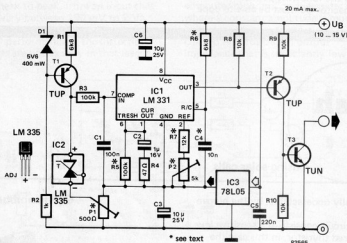

frequency generator

a CMOS crystal controlled oscillator

One IC, a quartz crystal, three resistors and two switches are all that is required to obtain 16 different frequencies! Can it be more versatile than that? Motorola calls its IC MC14411 a 'bit rate generator' which can be used as a frequency source for numerous applications within the area of data transfer, such as teleprinters, video terminals and microprocessor systems. A quartz controlled oscillator

Table:

Pin Number	Output Number	X64	Output Rates (Hz) X16	X8	X1
1	F1	614.4 k*	153.6 k	76.8 k	9600
17	F2	460.8 k*	115.2 k	57.6 k	7200
2	F3	307.2 k*	76.8 k	38.4 k	4800
16	F4	230.4 k	57.6 k	28.8 k	3600
3	F5	153.6 k	38.4 k	19.2 k	2400
15	F6	115.2 k	28.8 k	14.4 k	1800
4	F7	76.8 k	19.2 k	9600	1200
5	F8	38.4 k	9600	4800	600
7	F9	19.2 k	4800	2400	300
6	F10	12.8 k	3200	1600	200
8	F11	9600	2400	1200	150
14	F12	8613.2	2153.3	1076.6	134.5
13	F13	7035.5	1758.8	879.4	109.9
9	F14	4800	1200	600	75
18	F15	921.6 k	921.6 k	921.6 k	921.6 k
19	F16*	1.843 M*	1.843 M	1.843 M	1.843 M

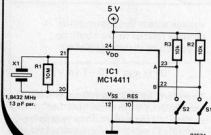

*F16 is buffered oscillator output

forms the 'master frequency source'. The oscillator signal is buffered at pin 19. Moreover, the signal reaches

Rate Select		Rate
B	A	
0	0	X1
0	1	X8
1	0	X16
1	1	X64

a divider that produces five different output signals: The oscillator signal divided by two is always present at pin 18, the other four signals (:1, :4, :8, :64) can be fed to a 14 stage divider, as desired. So, with the two switches (S1, S2) in the open position it already supplies 4 different signals. In addition there are 14 + 2 signals simultaneously available. The table

shows all the possible combinations. The output pins of the IC are not indicated in the circuit diagram, but are found in the table. One final remark: The IC can be 'fed' with an external clock signal via pin 21, so that the various division factors can be used to the full!

Source: Motorola

10

signal strength meter

with audio output

A meter of this kind is very useful for determining the radiation characteristics of directional beam transceiver aerials. It allows the user to trim the aerial accurately for an optimum transmitting radiation pattern.

An auxiliary aerial should be positioned a short way from the main transmitting one. The signal received by this is then fed to a resonance circuit formed by L1, L2 and the varicap C2. This enables the meter to be accurately tuned to the particular transmitting frequency to be measured. With the coil values shown in the circuit diagram the 'band width' of the meter is between

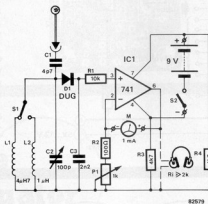

6...60 MHz. The RF signal is then fed to the diode D1, which constitutes a rectifier/demodulation stage. Finally the signal is routed to the non-inverting input of opamp IC1. The gain of this opamp and therefore the sensitivity of the 1 mA meter is adjusted by P1.

The prototype was found to be extremely sensitive, and highly selective. A pair of headphones can be connected to the output of the opamp allowing the actual transmission to be monitored. The overall resistance of these should not be less than 2k Ω otherwise an extra amplification stage will be required.

11

inverter oscillator

can be crystal controlled

Not another TTL squarewave generator?! Surely, there are plenty of them in other issues of Elektor? Yes, but this is an oscillator with a difference: unlike most of its counterparts its frequency is variable. In fact it may be adjusted over a wide range.

The circuit shown here consists of two inverters with one or two external components. Resistors R1 and R2 and the trimming capacitor C1 set the frequency. With the given component values, the oscillator frequency may be adjusted from 800 kHz to 12 MHz. The

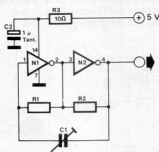

N1, N2 = 74LS04
R1, R2 = 560 Ω ... 4k Ω
C1 = 20 pF ... 80 pF

resistors set the frequency in just about the right region, whereas C1 provides the fine adjustment. The resistor values are not really critical; just make sure that they are both the same. The circuit is also suitable as a stable crystal oscillator. All you have to do is replace the trimming capacitor with a crystal with the corresponding frequency. Supposing, for instance, the oscillator frequency is to be 1 MHz, then the crystal will have to be a 1 MHz type.

12

serial keyboard interface

With a bit of luck it is sometimes possible to purchase a high quality keyboard without having to pay too much for it. Most of these keyboards have a parallel output that supplies an ASCII or Baudot code. Trying

to connect it to a personal computer will cause some problems because most computers are equipped with a serial RS 232 interface. The circuit described in this article will provide the solution to this problem; it

converts a parallel ASCII or Baudot code into a serial signal. The signal conversion is performed by a UART of which only the transmitter is used. The Baud rate is produced by a clock generator which is constructed using the well-known 555 timer. The clock frequency must be 16 times the Baud rate. The serial data signal is situated at pin 25 of the UART and is boosted to the RS 232 level by way of transistor T1.

The length of the serial 'word' can be set with the aid of the logic levels at pins 37 and 38. The logic level at pin 35 of the UART determines the setting transmitted parity or 'no parity'. With the circuit diagram shown in figure 1 the data word will be 7 bit long and will not contain a parity bit. (As a result pin 39 is not used.)

Literature:

'Elektterminal':
Elektor December 1978,
p. 12-16 ... 12-25

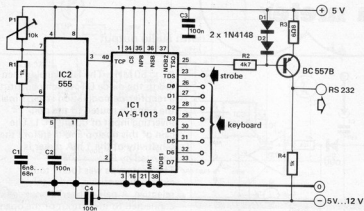

13

RF amplifier for the 10 meter amateur band

The VN66AF manufactured by Siliconix has quite a few advantages, over its rivals; good value for money, in terms of price per watt, high dielectric strength and exceptional gain. It also has a low tendency to

oscillate. The most common application for VMOS FETs is in power amplifiers, but, that is not a reason to discount them for any other use. They have been used successfully in pre-amps, and RF amplifiers. In this

particular case it is used as an RF amplifier for the 10 metre amateur band (26 ... 30 MHz). Small transmitters of around 200 mW can be transformed into reasonably powerful ones delivering between 2 and 3 W by using the circuit described here.

The design is fairly straightforward. The fixed filter network positioned at the output, suppresses noise by as much as 55 dB.

If the coils are constructed to the specifications outlined in the parts list, then the filter will not require calibration. Obviously experienced hands may wish to change the specification and the design is sufficiently flexible to allow this. The amplifier is suitable for most types of transmission

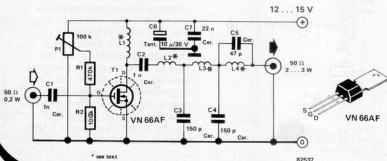

mainly because the drain current from the FET can be varied, by P1. For linear applications (AM and SSB), the drain should be set to 20 mA. When used for FM and CW, P1 should be adjusted so that no quiescent current is flowing.

For the application that the original design is meant for the quiescent current should be between 200 mA and 300 mA. The ready made printed circuit board ensures speedy and accurate construction. The coils should be wound onto

aerial coil formers with a diameter of 9 mm. Care should be taken to lay the windings close together without any apparent gaps. It is advisable to use a heat sink for the FET.

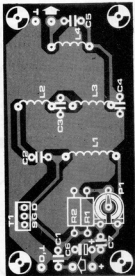
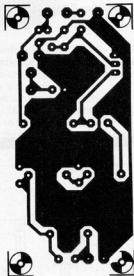

Parts list

Resistors:

- R1 = 470 k
- R2 = 100 k
- P1 = 100 k preset

Capacitors:

- C1, C2 = 1 n ceramic
- C3, C4 = 150 p ceramic
- C5 = 47 p
- C6 = 10 μ /35 V tant.
- C7 = 22 n ceramic

Semiconductors:

- T1 = VN66AF
(Maplin, Watford Electronics)

Coils:

- L1 = 12 windings 0.6 mm enamelled copper wire
- L2 and L4 = 5 windings of 1 mm enamelled copper wire
- L3 = 8 windings 1 mm enamelled copper wire

14

active attenuator

for measuring instruments

J. Bartels

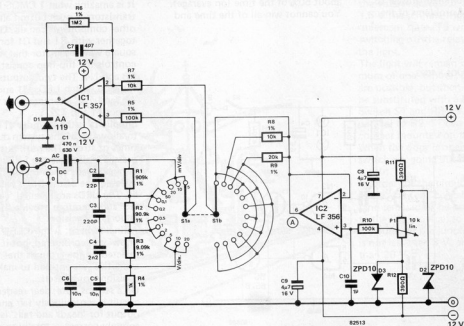

Although countless measuring instrument preamps have been published in recent years, none of them would have served their purpose, if they could not attenuate the input signal. This is required, in order to ensure that the full scale of the measuring instrument is utilised to the full. As a matter of interest the attenuation, in most cases, is effected in steps of 1, 2 or 5.

The circuit described here divides the input signal into 12 steps covering a range from 5 mV (the most sensitive setting) to 20 V. Capacitors C2... C6 are included for frequency compensation. The range switch consists of two twelve way wafers, S1a and S1b.

With the help of S1a the input signal is divided into 4 attenuation steps. At the same time S1b allows the gain of IC1 to be adjusted in three steps. The result is that for every attenuation step there are three levels of gain. Preset P1 adjusts the off-set voltage level of IC1 via the buffer IC2. To achieve best results, a screen should be placed between the two wafers.

The result is an extremely useful input circuit for AF meters. It is ideal for hobbyists, as no special effort or components are involved. The circuit is of course equally suitable for oscilloscopes. During construction, make sure that the two switches are screened from each other and from the

rest of the components, as otherwise it will be impossible to separate the 'sheep from the goats', or rather, tiny input signals from interference. There is no need to calibrate the circuit! If desired, the offset adjustment may be omitted. Instead, earth point A and leave out the whole offset calibration circuit, including P1 and IC2.

15

executive decision maker

heads or tails

These troubled times bring enormous problems to bear on the higher echelons of our business community. Now, the far-reaching effects of an incorrect decision can be more serious than ever before. Unfortunately many important decisions have to be made during moments of high pressure. You may well ask how our world of electronics can alleviate this horrifying situation. It may surprise many readers to know that we have here, in this little circuit, the complete answer to 50% of all business problems of the

world!

The executive decision maker is capable of taking command in matters where an all-important decision is to be made. At the press of a button the 'silicon chip technology' will mercilessly grind away at the pro's and cons and provide a 'yes' or 'no' answer in fractions of a second. Think what this could do for commerce.

There is of course, just one little snag, it can only give the correct answer for about 50% of the time (on average). You cannot win all of the time and

anyway, 50% is not a bad average in some circles!

On now to our electronic genius. We must confess that the original design was scrapped due to problems with 3 of the microprocessor systems and one 42 M byte bubble memory that failed to work. However, after a little electronic pruning the circuit was whittled down to the final design shown here, somewhat smaller admittedly, but the results are the same! It is amazing what 1 CMOS IC, 2 transistors, a push button and a few other components can do. Gate N1 together with R1 and C1 forms a square wave oscillator that, via N2 controls the flip-flop consisting of N3 and N4. The two outputs of the flip-flop switch LEDs D1 and D2 'on' and 'off' alternately via transistors T1 and T2.

Simplicity is the keynote of operation to allow use of the system during times of stress. The push button, when pressed, will cause the LEDs to flash at high speed. When the push button is released one of the LEDs will remain lit. The LEDs are labelled 'yes' and 'no' and therefore provide the all-important decision.

A final remark: A third LED for 'don't know' was considered, but it was rejected on the grounds that today's executive was entitled to make some decisions for himself. . .

On a serious note, dear readers, the circuit is scrupulously fair and the output for 'heads and tails' is absolutely correct — totally random!

N1 ... N4 = IC1 = 4093

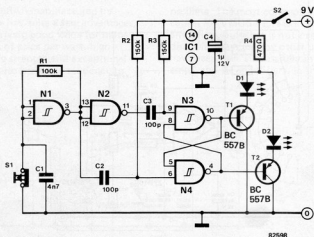

82598

16

automatic outdoor light

shine a light on your door

The purpose of this circuit is to automatically switch on an outside light to illuminate your front door, when a visitor arrives.

The circuit uses a light detecting resistor (LDR) as the sensor. For the circuit to work an external light source such as a lamp post is required.

J. Bodewes

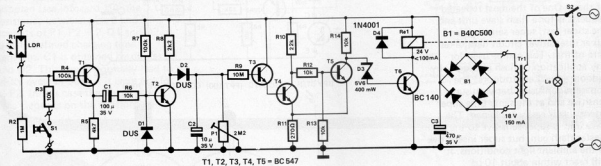
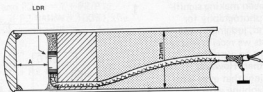

82847

Needless to say this source needs to be close by. Please remember that the removal or repositioning of lamp posts needs the authority of the local council, so we do not recommend this circuit to anyone who has to extensively remodel the landscape. The LDR is mounted into a tube, behind a lens, and aimed at the light

source. This structure is positioned, so that the person approaching the front door, causes a shadow to fall onto the lens. Do not forget to ensure that the tube containing the LDR is water tight. Immediately the LDR is in shadow, its resistance will increase. This results in T1 applying a negative pulse to T2 via C1 and R6. T2 con-

tinues to conduct until this negative pulse arrives. As soon as T2 cuts-off, C2 starts to charge. When the voltage across C2 rises above 2 V, the schmitt-trigger formed by T3, T4, T5 (and their surrounding components), switches on transistor T6. T6 conducts and triggers the relay, which switches on the outside light. The rate at which C2 discharges is adjusted by P1. When the voltage across C2 falls below 1.5 V the schmitt-trigger returns to a quiescent state. T6 will cut-off switching off the relay and therefore the light.

The light will remain on for a maximum of one minute. Longer periods are possible, but then C2 will have to be substituted with a larger capacitor. Switch S1 and R3 are connected in parallel to R2. S1 can be a make/break contact mounted on the front door. When the door is opened the light will switch on, going out immediately it is shut.

In order for the circuit to work effectively, the tube containing the LDR (and lens), must be positioned, relative to the light source, so that the voltage measured at the junction of R1, R2, is not less than 3 V, and not more than 20 V.

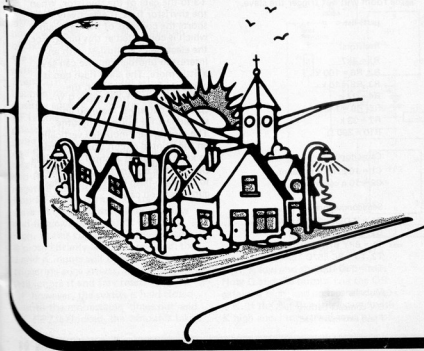

17

slave flash

fast, sensitive and reliable

Electronics have been making significant inroads into photography for some time now and, judging by the number of requests we receive, many of our readers want to push the frontiers even further. However, there are a few things that even we dare not do and dabbling with the insides of an electronic camera is one of them. One of the most repeated requests is for a flash slave unit and the super fast, super sensitive (and super insensitive) circuit here takes care of that. This can be used for any application of flash photography indoors as well as outdoors. The apparent confusion between super sensitive and at the same time super insensitive is easily explained. The slave unit is super sensitive to the master flash gun and the super insensitive to the ambient light conditions. It will react within about $10 \mu\text{s}$ depending on the light power of the master flash gun. This means that when using a computer controlled flash gun with a flash duration of 1 ms, 99% of the slave flash is included in the computer's calculation. This makes it especially ideal for use with automatic flash/camera systems. The total range of the slave is set by means of T1, R1, R2 and D1. The setting is to achieve maximum sensitivity in low and average light levels.

1

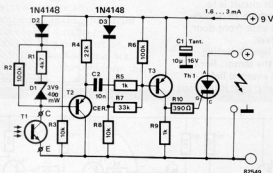

BPY 61/II

BC 557C

(FPT 100)

BC 557C

TIC 106D



CAG

A special shield for difficult light conditions is not normally required. However, if the slave is to be used for daylight fill-in flash photography then a certain amount of protection from sunlight will be advantageous. On the other hand, switching a normal incandescent lamp on and off in the same room will not trigger the slave.

There is very little to be said about the circuit itself and photographers with sufficient electronic know-how will be satisfied with the following information. A brief flash from the master reaches photo transistor T1 and causes a pulse at the base of T2. This pulse is boosted and passed via T3 to the gate of the thyristor. When the thyristor fires, it effectively shorts the contacts of the flash gun which is connected at this point. For the electronics enthusiast with an interest in photography we can say a little more. The slave flash gun is connected in parallel with the thyristor. Apart from this a 9 V compact battery is required and should last for quite a long time. The resistors are mounted vertically on the printed circuit board in order to keep the board as small as possible. One further tip, for the connection to the slave flash gun use ... a flash gun extension cable!

parts list

Resistors:

- R1 = 4k7
- R2, R6 = 100 k
- R3, R8 = 10 k
- R4 = 22 k
- R5, R9 = 1 k
- R7 = 33 k
- R10 = 390 Ω

Capacitors:

- C1 = 10 μ /16 V tantalum
- C2 = 10 n ceramic

Semiconductors:

- D1 = Z-Diode 3V9/0,4 W
- D2, D3 = 1N4148
- T1 = BPY 61/II, FPT 100
- T2, T3 = BC 557C
- Th1 = TIC 106D

Miscellaneous:

- 9 V compact battery
- Flash extension lead

2

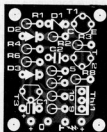
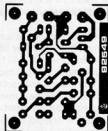

G. König

18

555 pulse generator

... with variable duty cycle

This circuit may look familiar to many readers since it is one of the many variations of circuits on the 555 timer theme. This does not detract from its usefulness however since a versatile pulse generator with a variable duty cycle is an excellent aid for the workshop.

Unlike the standard circuit usually adopted (see infocard 19), the resistance between pins 6 and 7 consists of P1, P2, R2, D1 and D2. A closely defined charging time for capacitor C1 is obtained by diodes D1 and D2. This would normally lead to a duty cycle of 50%, if it were not for P2. In this case the duty cycle depends on the relationship

between P1 and P2: $n = 1 + P2/P1$. For example, if P2 = 0 ($n = 100\%$), the frequency will then be:

$$f = \frac{0.69}{(2 \cdot P1 + P2 + 4.7 \text{ k}\Omega) \cdot C1}$$

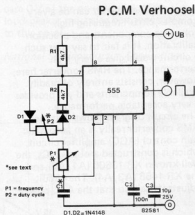

19

pushbutton interface

combined debounce and latch function

The circuit here extends the effectiveness of the simple push-to-make switch by enabling it to be used as either a 'one-shot', with clean, debounced edges, or as a push-on/push-off latch. These functions remove the problems associated with any switch, that of electronic 'noise'. Resistor R1 'debounces' the switch and provide a positive edge to trigger the monostable FF1. This generates pulses (in anti-phase) at its Q and \bar{Q} outputs. The pulse width is determined by R1, R3 and C2. The positive pulse (Q) is fed to an 'OR' gate consisting of D2, D3 and R5. The trailing edge of the negative pulse is used to trigger flip-flop FF2. The normal (or stable) state of FF1 is with its Q output low and (logically enough) its \bar{Q} output high. In this condition, if the switch is closed briefly and then released, the J and K inputs will be low when the triggering edge arrives. In this case FF1 will ignore it and stay reset.

If, however, the switch is held closed until the monostable 'times out' and FF2 is clocked, the J input is taken

high, K low and the flip-flop 'flips'. Now Q and the output (via the OR gate) are high, and consequently, so is K. If the flip-flop is triggered with K high and J low it will revert to its

reset state. Holding the switch closed will not affect the circuit action, for with both J and K high, FF2 will change state on the arrival of a clock edge.

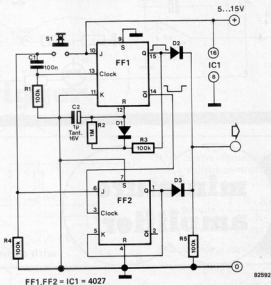

J. Ritchie

20

true RMS converter ...

... requiring no special components

A true RMS converter can be a very complex circuit requiring high tolerance components and precision calibration. It is fair to say that such a circuit would give a very high performance. The RMS converter here, however, consists entirely of readily available components and yet provides a very acceptable performance.

The circuit diagram shows that the RMS converter really is an automatic gain control (AGC) amplifier circuit, which is constructed around 2 ICs, the well-known XR 13600 (A1, A2) and the XR 1458 (A3, A4). The circuit adjusts its gain so that the A.C. power

of amplifier A1 remains constant. This output level is monitored by the squaring amplifier formed by A2 and the average value is compared to a reference voltage with the aid of A3. The output of this amplifier provides the diodes of A1 with bias current, via a 2 k Ω resistor and transistor T1, in order to attenuate the input signal. As mentioned before, the output power of A1 is held constant, therefore the RMS value remains constant as well. Obviously the attenuation is directly proportional to the RMS value of the input voltage and the diode bias current.

This leaves only the function of A4 to be discussed: This amplifier adjusts the ratio of current flow through the diodes, so that they are equal. Consequently the output voltage of A4 corresponds to the RMS value of the input voltage.

Last, but not least, the potentiometer situated at the input of this circuit, must be set so that the V_Q reads directly in RMS volts and can be calibrated by direct comparison with another RMS voltmeter.

EXAR application

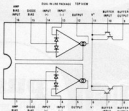
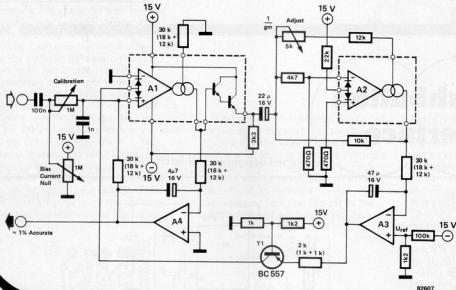

A1,A2 = IC1 = LM 13600
A3,A4 = IC2 XR 1458

82607

21

miniature amplifier

... with active tone control

There are many ICs available today that contain all the circuitry required for various versions of power output stages. The IC presented here goes even further than that. It can be used as a complete amplifier.

Obviously it is not super hi-fi but for a second (or third) amplifier it is quite good enough. The IC LM 389 was featured in the Summer Circuits issue last year. In that case it formed the basis for a small siren. The resemblance between

a siren and an amplifier is quite obvious and the natural progression is published here.

The IC contains a small power output stage and three further transistors on the same chip. This means that no

further active components are required for the amplifier. The gain of the output stage is simply set by means of a capacitor and a resistor. In the circuit diagram the gain is set at 20x (26 dB) which means that pins 4 and 12 are simply left floating. If a 10 μF capacitor is connected between these pins, the gain increases to 200x (46 dB) and 50x if a 1k2 resistor is inserted in series with the capacitor. Transistor T1 is used as an emitter follower (high input impedance/low output impedance). This sets the input impedance of the circuit to approximately 50 kΩ. The so-called Baxandall tone control is formed by the networks R5 ... R8, C4 ... C7

and P1 and P2. Transistors T2 and T3 are the active part of the tone control circuit and ensure a gain of 1 to 1 in this stage. The signal is then fed to the power amplifier via the volume control P3. The output stage is not given in detail here, but simply as a block, IC1. The maximum output power into a 4 Ω load is about 300 mW with a distortion figure of 10%. With an 8 Ω load this becomes 600 mW again with 10% distortion. If the maximum output power is required with a 12 V supply, it is advisable to use a heat sink for IC1. Readers who would prefer a lower distortion figure can achieve this by limiting the power output to 120 mW. This presents a

reasonable distortion figure of 0.2%. The minimum input voltage for maximum output is approximately 100 mV for a 4 Ω load and 150 mV for an 8 Ω load. Obviously modifying the gain is going to alter the input sensitivity up to a factor of 10. When constructing the circuit a few points must be watched. Pin 18 of the IC is connected directly to the central earth connection of the circuit, in this case 0 V of the power supply. The loudspeaker must also be connected to this point.

National Semiconductor Application

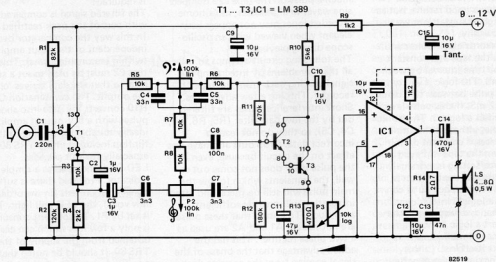

22

OTA Schmitt-trigger

switching with the 13600

If the voltage at the differential input of an OTA, such as the XR/LM 13600, is strongly positive or negative, the output current will equal the maximum value I_{ABC} . Furthermore, a Schmitt-trigger with trigger points to the value of $\pm I_{ABC} \cdot R_V$ is obtained when the output voltage (across load resistor R) is identical to the voltage at the positive input. Therefore the switching hysteresis depends on I_{ABC} :

$$\text{hysteresis} = 2 \cdot I_{ABC} \cdot R \text{ volt}$$

The control current I_{ABC} can be influenced by changing the value of R_C . Alternatively, a control voltage

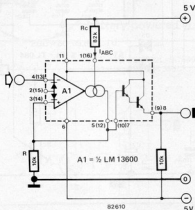

(U_C), can be connected across R_C , so that a voltage controlled hysteresis is obtained.

$$\text{hysteresis} = \frac{2 \cdot R \cdot (U_C + 3.8)}{R_C} \text{ volt}$$

Exar/National application

23

TRS 80 cassette interface rediscovered

recorded data cleaner

The TRS80 computer is a fairly good machine, but the cassette interface has already driven many an owner to the depths of despair. Why the tapes are read back so unreliably has never been worked out, but despite this fact there are a number of suggestions on how to improve matters. The circuit given here also produces good results, but as with so many good suggestions we do not really know why.

The TRS80 records clock pulses and data pulses on the tape at a constant amplitude. The time interval between pulses is 2.4 mS. The logic is written by inserting a pulse between two clock pulses after 1.2 mS. If this pulse is not there this signifies a logic 0. The ironic thing now is that although the amplitude of the pulses is constant during recording, when the tape is played back the volume setting is extremely critical. One possible explanation is that one small interference pulse can easily convert a logic 0 into a logic 1. On the other hand, a drop out in the tape can convert a logic 1 into a logic 0. Matters get even worse if a clock pulse gets itself lost. In this case, a following data pulse may be

recognised as a clock pulse, and from this point onwards the whole thing gets totally out of hand. The situation deteriorates still further when playing back commercial tapes. These are very often recorded at high speed, and this has the effect that there is not so much a pulse on the tape as a damped sine wave. In all fairness, most home recorded tapes may not appear very elegant when viewed with an oscilloscope during playback.

The following circuit attempts to solve all these problems by integrating the signal coming back from the tape recorder. This has a few advantages. Short interference pulses are filtered out by the low pass filter (R5, R6, R7, C4, C5), so they do not lead to incorrect data. Drop outs also have less effect on the circuit because, even if the pulse itself does not come out so well, the transients which follow the main pulse will still be there, and after integration will provide sufficient amplitude. To ensure that these pulses are not missed A1 and A2 are used as a two phase rectifier. This has the added advantage that the phase of the signal coming from the cassette deck is

completely unimportant. The rectified signal is passed on to the filter and also a peak detector D3/D4 and C2. When the amplitude of the cassette deck output varies a little (when an older or a different type of tape is used), no critical adjustment of the output level is required.

The filtered signal is compared in A3 with part of the peak rectified signal. In this way the comparator becomes independent of the input amplitude (within reasonable limits). This means that P2 must be used to set a suitable level so that the data arrives 'clean' at the output. The combination C6 and R10 converts the data into short pulses with a 5 V output amplitude ideally suitable for passing to the flipflop included in the TRS80, especially for this purpose.

LED D6 is included as a simple indicator. Provided there is sufficient signal level present (in the order of a few volts), the LED will light. The gain is set by P1. The current consumption is only a few mA which can easily be obtained from the supply of the TRS80. It should be noted that D6 can draw up to 50 mA if it is included.

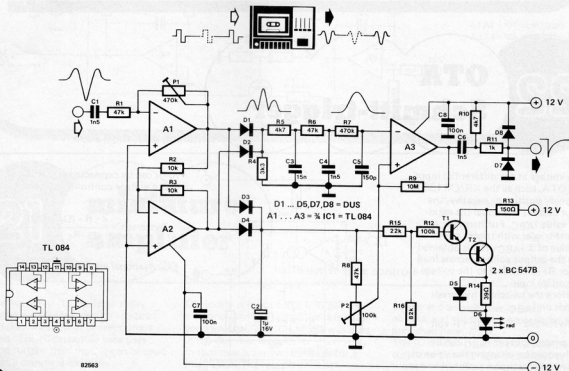

24

mixing
console

single opamp audio mixer

The majority of audio mixer circuits published to date in Elektor (and other magazines) require a relatively large number of components. However, a simple unelaborate system could also prove effective, especially when only a few signals are to be mixed together.

The circuit described here utilises a single opamp as the summing amplifier. The individual input signals are connected to the 100 k Ω 'adder' resistors at the inverting input of the opamp, after being fed through the 'mixing' potentiometers. Normally, there will be no need for any series

capacitors to be connected to the inputs, as the majority of today's signal sources do not produce a DC voltage level. Nevertheless, if it is considered necessary, 330n capacitors could be included.

Readers may add as many inputs as they like. The overall quality depends entirely on the type of opamp used. Recommended types are TL071 or TL081, but a 741 will also perform satisfactorily. The summed signal is amplified by a factor of 4.7 and the output level can be adjusted as required. The output is short-circuit proof and has a very low impedance. The input impedance (which can be adjusted by means of the 47k Ω potentiometers) is approximately 40k Ω . This means that most commonly available signal sources, such as tuners, cassette decks, tape recorders etc., can be mixed together without any difficulty. Dynamic microphones and turntables with magnetic cartridges do, however, require a small preamplifier.

For a stereo system the circuit is simply constructed twice and tandem potentiometers are used. The circuit can be powered by 9 V (PP3) batteries as the current consumption of the opamp amounts to fractions of milliamps.

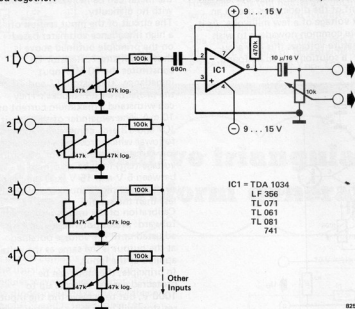

25

low voltage
stabiliser

battery powered voltage regulator

Depending on their condition 1.5 V batteries supply a voltage of 1.2 ... 1.7 V. This circuit can be very useful when a project has to be fed with a constant, low voltage. With an input voltage of 1.2 ... 1.8 V this stabiliser produces a relatively constant voltage of 1.15 V with a maximum load of 5 mA. T2 cuts off at a minimum battery voltage of 1.2 V with a load of 5 mA. The output voltage tends to increase with a higher battery

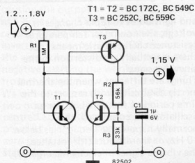

voltage, causing T2 to conduct and reducing the base current of T1 and T3 (indirectly), so that the output voltage will remain 1.15 V. The internal impedance of this low voltage supply is 1 to 2 Ω . The output voltage will only be reduced by 70 mV when changing the battery voltage from 1.8 V to 1.2 V.

(ITT application)

26

overvoltage protection for meters

10 M Ω input impedance

Normally, the high impedance input of the 'front end' amplifier in a digital voltmeter is protected against excessive voltages by means of two diodes. One diode is connected between the input and the positive supply rail, while the other is connected between the input and the negative supply rail. In principle, this form of overvoltage protection is perfectly satisfactory.

However, the diodes used would have to have a very low leakage current.

The main problem here being that they are relatively difficult to obtain and also they tend to be rather expensive. Electronics enthusiasts prefer to utilise general purpose devices such as the 1N4148 silicon diode. This does mean that with an input impedance of 1 M Ω the leakage current of the diode gives rise to an offset voltage of a few millivolts. As it is quite common nowadays to wish to measure voltages this low accurately, a solution had to be found.

By replacing the diodes with FETs, the following result is obtained. With a reverse bias voltage of 15 V the diode has a leakage current of 5.2 nA, whereas the leakage current of the FET 'diode' is a mere 12 pA! This means that the input impedance of the meter can be increased to 10M Ω with no difficulty.

The circuit of the input section of a high impedance voltmeter based on the principle outlined above is shown in figure 1. Resistor R1 constitutes the 10 M Ω input impedance. Transistors T1 and T2 are the protective FET 'diodes'. They can withstand a maximum current of 10 mA. The remainder of the circuit, IC1 and T3 etc., comprises a voltage follower which provides a relatively low output impedance. The operating voltage (U_B) may be anywhere between 5 V and 15 V, and the rating of the zener diode should be two volts less than the supply.

Calibration of the unit is very straightforward: preset potentiometer P1 is adjusted until the voltage obtained at the output is the same as the voltage applied at the input.

In principle, the input can be protected against voltages up to 1000 V, but to achieve this the input resistors will have to be suitably high-voltage types.

$$5 \text{ V} < U_B < 15 \text{ V}$$

$$U_Z = U_B - 2 \text{ V}$$

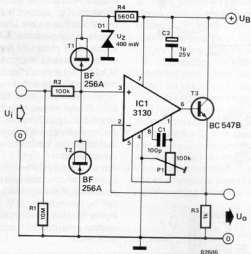

27

stable amplitude low frequency oscillator

for vibrato

Thermistors and even light bulbs have often been used in oscillator circuits to stabilise the output amplitude. The resistance of such components is dependent on temperature and therefore on the effective voltage across the particular component. The curve of resistance versus temperature ensures that the sinewave signal generated by the oscillator is stabilised so that it is virtually distortion-free. Due to the fairly slow response of thermistors

and light bulbs to rapid changes in voltage, the non-linear temperature/resistance characteristic means that there is virtually no distortion in the sinewave signal.

Things are different when the thermal inertia diminishes with respect to the time period of the signal. As far as oscillators are concerned, this normally happens at frequencies below 10 Hz, or thereabouts (for instance, the vibrato signal in electronic organs).

This means that in this application a different approach will have to be taken.

In the circuit described here a zener diode is used to limit the voltage. A bridge circuit (comprising resistors R1 and R2 and capacitors C1 and C2) determines the frequency of the oscillator. For the circuit to oscillate, the active devices (T1/T2) must give a gain of almost exactly X3. When the amplitude of the output signal rises,

the zener diode starts to conduct and reduces the gain of the amplifier stage, thereby damping the oscillation so that the sinewave tends to decay. In order to prevent the zener diode from limiting the output signal too abruptly, resistor R5 is connected in

series with the zener diode. This combination is in turn connected in parallel to resistor R4. Once the voltage threshold of the zener diode is reached the impedance of the network will gradually diminish allowing the sinewave to be stabilised in a 'gentle', low-distortion manner.

Even though only the positive half-cycle of the sinewave signal is in fact limited, the negative half-cycle does not last long enough to allow the amplitude to rise significantly. Potentiometer P1 should be adjusted carefully to avoid severe clipping of the output signal. The negative half-cycle of the signal is extremely linear, but the positive half-cycle is slightly distorted due to the limiting. However, this will not be a problem where most applications (vibrato etc.) are concerned.

The oscillator output voltage can be adjusted by means of potentiometer P2 between 0 V ... 4 V_{pp}. The

frequency of the oscillator can be determined from the formula:

$$f = \frac{1}{2\pi R1 C1} \quad (R1 \approx R2; C1 = C2)$$

This gives a frequency of around 6 Hz with the values shown on the circuit diagram (0.01 Hz with the values shown in parentheses). Resistors R1 and R2 should have a value of at least a few hundred kilohms. Lower values may overload the amplifier stage and with excessively high values the input impedance of the amplifier starts to play a role. At very low frequencies the negative half-cycle of the sinewave signal may start to clip, which will lead to considerable distortion. The DC component of the output signal may be filtered out by including a high value electrolytic capacitor in series with the output.

ITT application note

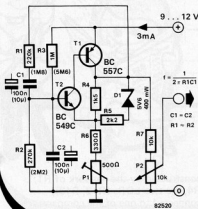

28 positive triangular waveform generator

This circuit contains a small addition to the usual two opamp square/triangular waveform generator. This is the diode included in the feedback loop of IC2 and is responsible for the rather strange behaviour of the oscillator. The triangular waveform output is entirely positive in contrast to a conventional circuit. Without the diode the output will be a waveform that is symmetrical about the zero axis. All this is necessary because some equipment, such as curve tracers, are unable to process a negative waveform.

We start the operation of the circuit with IC2. When the output of this opamp goes negative the diode will conduct passing the negative potential to pin 3 (non-inverting input). Since the inverting input, pin 3, is grounded the output will remain negative. This output is also fed to the inverting input of IC1 via R1. The output of this opamp does not change suddenly however, but due to C1 charging, begins to rise at a linear rate. When this voltage reaches the point at which pin 3 of IC2 becomes positive, the output of this opamp will 'flip over' and also become positive. The inverting input of IC1 will follow suit ending the charge cycle of C1.

This capacitor will now discharge causing the output of IC1 to fall, again at a linear rate. The diode is now reverse biased so that when the non-inverting input (pin 3) of IC2 reaches the zero point, its output will again go negative, starting the whole procedure from the beginning.

We end up with an oscillator having two outputs, one a square wave centred about the zero axis, and the other a triangular waveform above the zero point, which is exactly what we started out to get!

The peak to peak voltage of the triangular waveform can be calculated from the following formula:

$$U_s = -U_B \cdot \frac{R2}{R3}$$

The frequency can be found as follows:

$$f = \frac{1}{2 \cdot R1 \cdot C1} \cdot \frac{R2}{R3} \quad \text{where } R3 > R2$$

Using the formulae here, a frequency of 100 Hz is obtained at 5 V peak to peak ($U_B = 15 V$).

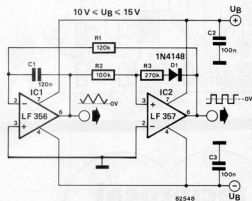

R. Storn

29

smoke detector

the optical method of detection

Smoke detectors are part of any sophisticated alarm system. Most of the professionally made ones use some form of gas-sensor, ionisation-chamber, or radio-active element. The circuit described does not use any of these rather complex components but makes good use of two light detecting resistors (LDRs), and a LED.

A special IC LM1801, allows the circuit to be constructed using the minimum of components. It is an IC designed specifically for use in smoke detectors, containing among other things, an internal supply zener, two

reference voltage outputs, a voltage comparator, and a 500 mA output transistor with clamp diodes. The complete circuit is connected to the mains supply. Diode D1 rectifies the supply, R7 reducing the voltage to a workable level for the IC. Capacitor C2 smoothes this, and the internal zener of the IC stabilises it.

The circuit uses a pair of balanced light detecting resistors (LDRs). By using these in a bridge arrangement, any changes in resistance due to temperature or aging effects are cancelled out. This bridge circuit is



constructed by the network of R1, R4, the two LDRs (R12, R13), connected to one of the comparator's inputs from the junction of R4 and R13. The other inputs for the internal comparator are from the junctions of R1, R12 and the voltage divider R2 and R3. This arrangement ensures that both LDRs are biased at the same voltage to ensure proper tracking. Physically, the LDRs should be situated such that smoke particles will reflect light from the LED (D2), onto R13, causing its resistance to drop. As soon as the comparator detects this drop in voltage, the IC triggers the thyristor Th1, causing a mains powered horn to 'sound'. P1 adjusts the sensitivity of the circuit. The most difficult part of the construction is the placing of the LED and LDRs. Basically the LED should be positioned exactly in the middle of the two, ensuring that there is no air flow between the LED and R12. This can be easily achieved by placing a small perspex box around R12 and the LED.

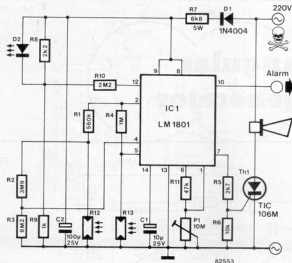

30

reciprocal amplifier

$$u_{out} = C/U_{in}$$

Many readers may judge that the subheading is rather simple. Just take a calculator and choose a number, then press the 1/X key and the result will be displayed instantly. However, to 'treat' a d.c. voltage this way, in order to use its reciprocal value in a measuring circuit, is something else entirely!

The normal circuit design for a reciprocal amplifier uses four ICs. Two opamps, ICs 2 and 4, serve as input buffer and output driver respectively. Half of a dual timer IC3a forms a clock oscillator for a modulator, IC3b (the other timer). Gates N1 and N2 convert the output signal of IC3b into a 'pure' square wave signal. This cir-

cuit is based on the PPM (pulse pulse modulation) principle and the variable pulsewidth of the square wave signal is dependent on the DC voltage level fed to the modulator. Note, the frequency remains unchanged! For example, if the input to the circuit is a high voltage level, the pulse width of the square wave signal will be small.

The output of IC3 is 'cleaned up' by gates N1 and N2 and then converted into a d.c. voltage level by the filter

network consisting of R6/C6 and R7/C7. We may have a reciprocal amplifier

now but this does not imply that a voltage of 10 mV at the input becomes 100 V (1/10 mV) at the output. Firstly, the input of the amplifier is limited to an operating voltage of no higher than 10 V. Secondly, from a mathematical point of view, $1/10 \text{ mV} = 100 \text{ V}$ is not quite correct. Therefore a correction factor 'C' has to be introduced. This is about $20 \cdot 10^{-3} \text{ V}^2$ when P1 is set to minimum. Now the output voltage level will range from 2 V to 20 mV with an input voltage of 10 mV . . . 1 V. The calibration procedure is very simple. Feed a voltage level of 20 mV to the input and set P2 so that exactly 20 mV can be measured between the emitter of T1 and U_b . As already mentioned, P1 determines the correction factor 'C' and last but not least, P3 takes care of the offset (if necessary). One final point, the supply voltage must be fully stabilised.

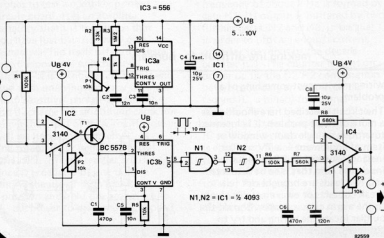

31

blinky

a creature from the world of electronics

Electronics can reach far beyond the frontiers of earth as a glance at the illustration shows. This electronic alien is a new arrival discovered by one of our extraterrestrial readers. In fact the entire population of the planet Kapa Sitor look like this when viewed from the other end of the soldering iron.

Their internal construction is shown in figure 1, which shows that, even with their 'way out' appearance, they are rather 'square'! A 555 timer-IC is used as square wave generator. The flashing (blinking) LED is not connected to the output (pin 3) as many readers might

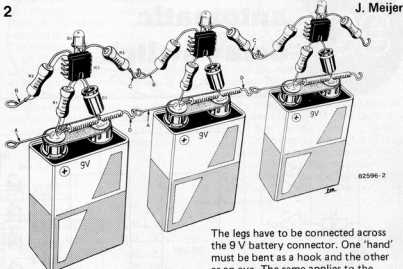
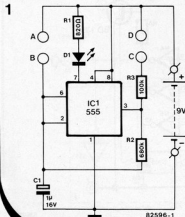

have expected, but to the discharge output. The reason for this peculiarity is the fact that the normal output is used to drive the other 'Blinkies'. Since they are symbiotic it is possible to obtain a complete Blinky family, living in complete harmony. Figure 2 shows how the Blinky family group must be made up. All the components are mounted carefully together as shown in the illustration.

The legs have to be connected across the 9V battery connector. One 'hand' must be bent as a hook and the other as an eye. The same applies to the connections A and D (do not forget the insulation sleeving). Finally interconnect them as illustrated in figure 2 and the electrical connections will be made automatically. If their body is 'deformed' in any way, they will not be able to carry out their allotted task in life: that of blinking out goodwill to the nations of the universe with their heads! And there is a lot to be said for that . . .

32

double alarm

making life difficult for burglars

Most alarm systems can be divided into two main categories. They are normally activated by closing, or interrupting a circuit loop. One of these basic principles is used irrespective of the electronic method adopted, (micro-wave, infra-red, photo-cells, contacts etc.). Today's burglar is not the simple-minded individual normally portrayed in comic strip cartoons. The professional certainly keeps up to date with the latest technological advances in alarm systems, and keeping him out is going to be difficult. Even part-timers unfortunately know something about electronics and alarm systems. Anyway the point is, that an average burglar can easily and quickly determine what principle the system uses and at least try to deactivate it. This is sometimes made easier for the thief, because the hiding of the connection

wiring may present something of a problem.

The circuit described here should pose a more difficult problem. It is intended to protect a single door, window or item of equipment — a TV set, for instance. A resistor, R2, is mounted inside the item that is to be protected and two leads are brought out (via break contacts or even an audio plug) to the alarm circuit proper. Should the burglar locate the wiring and try to either cut or bridge it, the alarm will activate.

Resistor R2 and the connections to capacitor C1 form a make or break loop. If the loop is interrupted or the two connection wires bridged (shorting out the hidden switch) the alarm will sound.

The circuit uses a window discriminator TCA 965. The operation of the

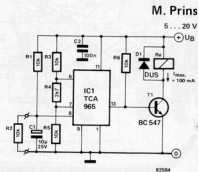

alarm is rather simple. When pin 8 receives a higher voltage than pin 6, or a lower voltage than pin 7, the IC will drive T1. T1 conducts and activates the relay Re. A high frequency mains driven horn connected via the relay, should be enough to panic the thief.

33

automatic delay switch

... with visual countdown

M. A. Prins

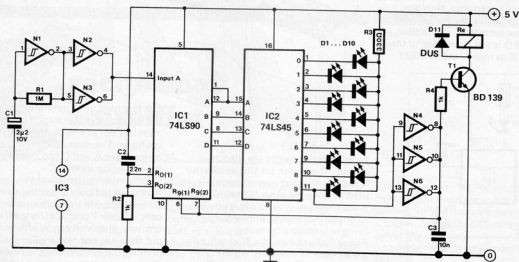

N1 ... N6 = IC3 = 40106

It is often said that two heads are better than one but this numerical advantage applied to hands could also be a great asset, especially when using probes to test a complex printed circuit board. It is an absolute certainty that the test probe that you have just painstakingly connected will flip itself off at the instant that the power is switched on. Further, it is a known fact that it will land with unerring accuracy on the most 'sensitive' part of the circuit — and discharge the smoothing capacitor across the input of the circuit! How well we know the problem! The title of this circuit could well have been 'Frayed temper adjuster' since it is capable of just that. It allows the use of both hands to position and hold the probes while the power to the circuit is applied

automatically, after a short delay. It even tells you (visually) when this is about to happen. An astable multivibrator with a frequency of about 2 Hz is formed by gate N1. Its output is buffered by two further gates, N2 and N3, in parallel in order to provide enough current drive for the input of the decade counter IC1. The counter is reset on power up by the C2/R2 combination before providing an output to the second IC, a binary-to-decimal decoder. The first of the ten LEDs connected to the output of this IC will light two seconds after power is applied to the circuit. It will be followed at 2 second intervals by the other LEDs until D10 lights after a total of 20 seconds. As can be seen from the circuit diagram, the final output at pin 11 is

buffered by the gates N4...N6 in parallel. These provide sufficient base drive current to allow transistor T1 to activate the relay at the same time that D10 lights. Power to the circuit under test is then provided via the relay contacts (not shown here) and will remain until the delay circuit is switched off. This 'latch' is provided by the link between the N4...N6 outputs and pins 6 and 7 of IC1. The time periods can be varied by altering the value of resistor R1, a larger value will lengthen the time. A simple stabilised supply consisting of a 7805 regulator can be used to power the delay circuit. However, the 'delay on' switch should be placed between the regulator and the delay circuit to ensure that the initial reset works reliably.

34

dynamic RAM for SC/MP

refreshing for SC/MP systems

The dynamic RAM card in the April 1982 issue of Elektor has found many friends among Junior Computer owners. However SC/MP owners will also be pleased to discover that the same RAM card can be used by them. As a reward to all the SC/MP owners (for staying with us for so long), here are the modifications required to adapt the dynamic RAM card to their systems. 16K in 8 ICs on a single card is worth quite a lot, and SC/MP users should find whole new possibilities for their systems. Unfortunately the

basic version was not suitable for the SC/MP system. This is due to the fact that the SC/MP system would interrupt the refresh instructions resulting in data being lost. The simple interface consists of a single IC, two resistors and two capacitors. Furthermore a set of wire links and connections (as shown in the table) must also be made. The circuit consists of a retriggerable monoflop MMV1, with a pulse length of approximately 10 μs. As long as the NADS pulses keep on coming, the

D. Paulsen

output 1Q is always at logic 1. This readies the second monoflop via N2 and N43 on the dynamic RAM card. If within 10 μs no further NADS pulses occur, 1Q becomes logic 0, and via N43 the second monoflop is triggered. 2Q provides a 300 ns pulse as a refresh instruction. The refresh signal also appears at the 2Q output of MMV2 and retriggers MMV1. Output 1Q will then become logic 1 again for 10 μs. This means in effect that as long as NADS pulses are not occurring the dynamic RAM is refreshed every 10 μs x 128 = 1.28 ms. The circuit can also be used for other systems with manual reset.

Table

Wire links on the RAM card
1-1', 2-2', A-B, J2, J3, J5, J6, J9

IC22 is omitted

Connections on RAM card
5' to +5 V, 3' to C

Connections from interface to RAM card
Pin 13/MMV1 to 4', Pin 9/MMV2 to Pin 12/
N43, Pin 1/MMV1 to J4-A-Pin 12/N1,
Pin 5/MMV2 to J4-J3-J5, Pins 3, 11, 10, 16,
R1 and R2 to +5 V, Pin 8

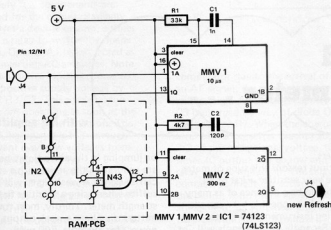

35

economical crystal time base

a 50 Hz 'bench mark'

This time base circuit is built using normal readily available CMOS ICs and a cheap crystal. The operation of this circuit is practically identical to that described in the 'Crystal stroboscope' article in the April 1981 issue of Elektor. The difference between the two projects is that whereas the first one only produced an output of 50 Hz, 100 Hz or 200 Hz, the 50 Hz reference frequency is an ideal time base for the construction or calibration of electronic clocks, frequency meters and so on. Because of the flexible supply voltage requirement, it is also a good basis from which to build a digital clock for the car.

IC1 contains an oscillator and a 2^{14} divider. Providing the oscillator

Parts list

Resistors:

R1 = 10 M
R2 = 100 Ω

Capacitors:

C1 = 22 p
C2 = 2...22 p trimmer
C3 = 10 μ /16 V

Semiconductors:

IC1 = 4060
IC2 = 4013

Miscellaneous:

X = 3.2768 MHz crystal

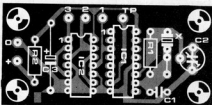
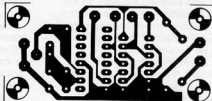

loop is correctly calibrated using C2, the output at pin 3 (Q14) will produce a 200 Hz square wave. With the help of the two flip-flops in IC2

this square wave voltage is then divided by two and then by four resulting in two further outputs of 100 Hz and 50 Hz, the latter from pin 1. Readers who have a frequency meter can calibrate the circuit by simply connecting the meter to pin 7 of IC1 (Q4) and adjusting C2 until a reading of 204.800 Hz is indicated. As a matter of interest, anyone without a frequency meter should not despair since setting trimmer C2 to about midway will provide sufficient accuracy for most applications. The 100 Hz output is useful for the construction of digital counters. For this purpose we suggest that a 1 : 10 divider (like the 4518) is connected to the 100 Hz output pin. The power supply requirements are:

from 5...15 V and 0.5...2.5 mA.

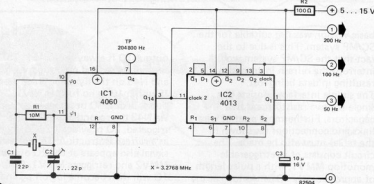

36

FET field strength meter . . .

. . . with RF amplification

A field strength meter is necessary when checking the power output and aerial of transmitters. With this circuit it is possible to measure the energy radiated by the aerial. This is useful not only for hams, but also CB enthusiasts and radio control

modellers.

For various reasons this type of meter must be very sensitive. First of all, there should be a distance of as many wave lengths as possible between the measuring instrument and the transmitter. Secondly, other people will not

be jumping in the air for joy when you are calibrating the aerial with a strong carrier signal. A weak signal will suffice when using a sensitive field strength meter. Thirdly, most transmitters only have a weak output power (for example, 500 mW).

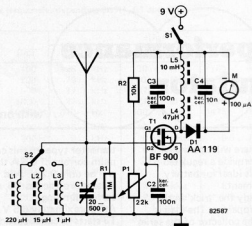

These are three of the main reasons why our field strength meter is equipped with an RF amplifier stage consisting of a Dual gate MOS-FET, T1. The amplification factor is set with P1. Switch S2 enables one of the three ranges to be selected: 480 kHz ... 2.4 MHz (L1); 2.4 ... 12 MHz (L2) and 12 ... 40 MHz (L3). A rod of approximately 30 cm will be enough to serve as aerial. As with all RF circuits, care during construction is necessary!

37

automatic switch . . . for output amplifiers

controlled from the speaker cables

People with a passion for hifi equipment and active speaker units are bound to have sought ways in which to switch on the output units via the pre amp. Funnily enough, many hifi manufacturers seem to regard automatic switch mechanisms as an unnecessary luxury. Automatic switches are, however, extremely useful and avoid having to lay yards and yards of leads throughout the house. Instead, a single or several 'remote' active units may be switched on by way of the original AF lead. As the switch mechanism is always 'listening in' anyway, it is also able to detect the prolonged absence of a signal, in which case it will simply switch off the output unit.

Relatively few components are required for the circuit. Basically, it involves a double opamp, a timer IC and a relay to switch the mains voltage. Opamp A1 is connected as a non-inverting AC amplifier. Note that its negative input is connected to the positive supply voltage by way of R3/C2. This prevents the relay from operating as soon as the supply voltage is switched on. The gain of the opamp is high enough to prevent even low voltages from de-energising the relay.

The second opamp, A2, is a comparator. P1 sets the switching threshold for AF signals at roughly 2.5 mVrms.

Should the output voltage of A1 exceed the threshold value of the

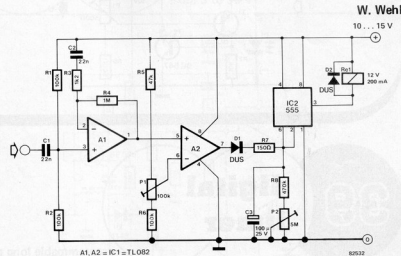

comparator due to the arrival of an AF signal, the comparator output will go high. As a result, capacitor C3 is charged by way of diode D1 and resistor R7. When the charge level of the capacitor reaches about 2/3 of the operational voltage, the timer IC output will go low and the relay will be pulled up. The relay contacts connect the active unit to the mains. If no more AF signals are applied, C3 will discharge via R8/P2 within 1 ... 5 minutes(s). The relay will then drop out.

The supply voltage for the circuit is derived from the mains by way of a 12 V or 15 V voltage regulator and a small transformer together with a rectifier and smoothing capacitor.

Warning! The relay contacts are connected to the mains, so take care when constructing the circuit.

38

mini high performance voltage regulator

... with only 1 V drop

One thing is common to virtually any voltage regulator; the input voltage level must be several volts higher than the expected output. Admittedly those fewer volts at the output are very nicely regulated. However, if for some reason there are very few volts at the input to start with, then there is a limitation in the output voltage range (far less volts to throw away!). In this case it is not possible to use a normal IC voltage regulator and we have to resort to a discrete design. The

circuit shown here will operate with a 6 V input and provide a regulated 5 V output, which is ideal for battery powered equipment.

With a little study the 'trick' in the circuit will be apparent. The load is connected to the collector of the series transistor. This means that this transistor can be switched hard on into saturation, so that the voltage between emitter and collector is only the very small saturation voltage. This voltage level depends of course on current and

transistor type. In this case at a maximum current of 0.5 A the voltage loss will be only 0.2 V. Add to this the voltage drop across R6, required for current limiting.

At approximately 0.5 V across R6, T3 starts to conduct and limits the output current. LED D1 has two purposes in life; as an indicator and as a voltage reference diode which sets a level of 1.5 V to 1.6 V at the emitter of T1. The base drive current for this transistor is derived from the voltage divider consisting of R4, P1 and R5. Depending on the difference between the reference and output voltage levels, T1 is more or less conducting. The same then applies to T2 which will supply more or less base drive to T4. Capacitor C1 is included to filter the output stage.

Instead of the BD 438 other well-known types can be used like the BD 136, BD 138 and BD 140 for instance. However, these transistors do have a slightly higher saturation voltage.

It must be noted that since D1 acts as a reference source, it must be a red LED. Other colours have different parameters.

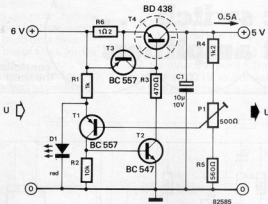

39

digital timer

programmable long time multivibrator

The analogue brother of this IC is our old friend, the 555. The digital version here, the LS 7210, is less well-known. It can be used to set delay times between approximately 11 µs and 42 minutes. The IC contains an oscillator of which the frequency determining elements are connected externally (R1 and C1). This then provides the frequencies as shown in table 1. The IC is programmed for internal oscillator operation by connecting pin 4 to 0 V. The delay time T is derived from the formula:

$$T = (1 + 1.023 \cdot N) / f$$

where 'f' stands for frequency according to table 1, 'N' is the multiplication factor as determined by pins 8...12. These pins have the following values: pin 12 = 1, pin 11 = 2, pin 10 = 4, pin 9 = 8 and pin 8 = 16. For example, if N is to be 25 then pins 8, 9 and 12 must be logic '0' (0 V). In this case, with the oscillator frequency set to 0.013 Hz, the total delay time will be 34 minutes.

As shown in the circuit diagram, the IC is used as a retriggerable monoflop. The output becomes logic '1' at the same time that a negative going edge

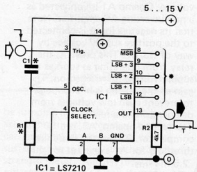

* see tabel 1 • see text

82589

Table 1. Oscillator frequencies depending on R1, C1 and +U_B.

R/kΩ	C/pF	+U _B /V		
		5	10	15
47	100	128 kHz	139 kHz	185 kHz
	200	79 kHz	83 kHz	85 kHz
	500	37 kHz	37 kHz	36 kHz
	1000	22 kHz	21 kHz	20 kHz
	50000	610 Hz	500 Hz	475 Hz
470	100	15 kHz	16 kHz	16.5 kHz
	200	9 kHz	9.5 kHz	9.5 kHz
	500	4 kHz	4 kHz	4 kHz
	1000	2.4 kHz	2 kHz	2 kHz
	50000	63 Hz	51 Hz	47 Hz
2000	100	4.2 kHz	4.7 kHz	5 kHz
	200	2.5 kHz	2.7 kHz	2.8 kHz
	500	1.1 kHz	1.1 kHz	1.1 kHz
	1000	670 Hz	617 Hz	610 Hz
	50000	17 Hz	14 Hz	14 Hz
10000	10 μF	.02 Hz	.015 Hz	.013 Hz

arrives at the trigger input, pin 3. The output level reverts to logic '0' at the end of the preset delay time period providing no further trigger pulses arrive at the input. Should this happen, the preset delay period will be initiated again, but the output will remain high. A positive input edge has no effect on the timing. The result of this is that, in principle, any length of time period can be realised by cascading 2 or more ICs in series. The output of the IC consists of a FET with open drain connection. Therefore, to obtain current switching between '0' and '1', a pull-down resistor, R2, is necessary. However, if the output is to be used as a current source this resistor can be omitted.

LSI application

40

converter for varicaps

from 3 to 30 V

The performance of varicaps is improved when the voltage across them is increased. Besides better intermodulation rejection, a 30 V circuit has a considerably higher Q than a 9 V version for the same capacitance variation. However, with battery-powered circuits, this high voltage will cause a problem, since deriving a tuning voltage of 30 V from a low supply voltage can only be realised with the aid of a converter. The circuit diagram shows the design for a converter especially constructed for this purpose. The LM 10C, from National Semiconductor, which contains two opamps and an internal reference source is ideal for this particular application. The oscillator is constructed around a

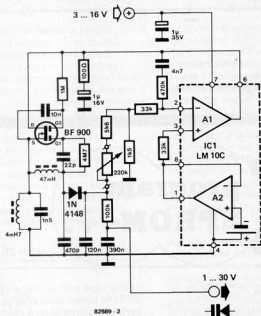
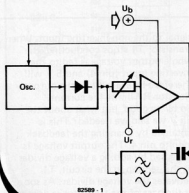

dual-gate MOSFET (type BF 900) and functions at a supply voltage as low as 1.5 V. The output voltage level of the converter is controlled via the supply voltage of the oscillator. Unlike most converters, this one does not have to be switched, so that there will be no distortion. The oscillator frequency is approximately 28 kHz. An AFC

voltage can be connected to one of the opamp inputs via a series resistor; which of the two inputs depends on the polarity of the AFC voltage. With the values indicated in the circuit diagram, the output voltage can be varied between 1 and 30 V by means of the 220 k potentiometer. The supply voltage can range from 3 to 16 V.

41

low octave switch

extended range with a monoflop

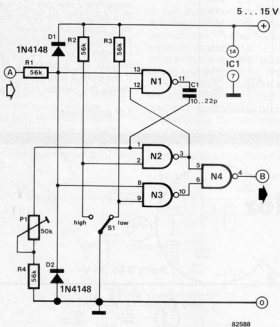

N1 ... N4 = IC1 = 4011
 A = from master oscillator
 B = to top octave generator

The limited five octave range of many electronic piano's and organs can be extended by one octave lower with the aid of the circuit here. It is connected between the main oscillator (input point A) and the highest octave generator (output point B).

A monoflop is constructed with N1, N2, C1, P1 and R4. Its time period is set by P1 so that the monoflop divides the frequency of the main oscillator by two, switch S1 provides the ability to switch between the original tone range and the extra lowered tone range. The diodes D1 and D2 protect the input against high level and negative input signals. The value of C1 depends on the frequency of the main oscillator, but can be found quite easily after some experimenting; the frequency of the piano or organ will suddenly be lowered by one octave when turning P1. If this does not occur, the value of C1 must be increased. When the correct value is found, the correct position for P1 is that when the frequency is lowered, plus a little extra 'tweak' to retain stability. This completes the 'calibration procedure'. A final note (!), the input voltage at point A must be at least 60% of the supply voltage.

42

program EPROM...

... with 25 V

After last year's welcome drop in prices of good quality EPROMs, computer enthusiasts have a great incentive for taking on more ambitious programming projects. Although normal operation calls for a 5 V supply voltage, 25 V is needed to program a 2716. In some types, the 25 V programming voltage need not be switched off while the operator checks freshly stored data. On the other hand, there are types for which the voltage has to be switched from 5 V to 25 V continuously.

It therefore follows that a suitable EPROM power supply has to meet certain requirements: it needs to be straightforward, fast (often the speed is specified by the manufacturer as being, say, between 0.5 and 2 μ s), accurate (no danger of overshoot or undershoot) and short proof. The well-proven 723 voltage controller IC fits the bill perfectly. As the circuit diagram shows, the 723 is at the heart of an ordinary 5 V power supply. Preset P1 limits the reference voltage (pin 6) to 5 V and feeds the

signal to the non-inverting input. When transistor T1 stops conducting, the whole output voltage is fed to the inverting input (pin 4) and 5 V will therefore be available at the output. Resistor R7 limits the current. So far so good, but what about the 25 V we said we needed? This is obtained by changing the feedback loop to pin 4. The output voltage is increased by adding a voltage divider to this section in the circuit. T1 activates the voltage divider. As soon as the base of the transistor is driven,

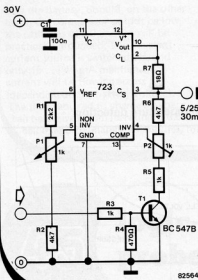

the 723 produces the 25 V voltage. In order to obtain different voltage levels the values of R5, R6 and P2, will have to be changed. Calibrate the circuit as follows: use P1 to set the output voltage to 5 V without driving T1. Then drive T1 by applying 5 V to R3 and set the output voltage to 25 V with P2. That's all there is to it! The upper trace in the photograph represents the signal controlling T1 (between 0 and 5 V) and the lower trace shows the output signal. The 723 is especially fast because pin 13, the frequency compensation input, is not used here. Normally speaking, a grounded capacitor is included at this point to smooth the signal edges. Note that it takes the output signal another 2 μs to go low again, once the control signal has gone low. This is because it takes transistor T1 quite a

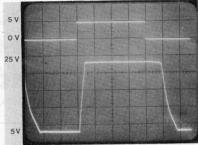

while to stop conducting. In applications where the time factor is highly critical, this may be a problem, in which case it is best to replace T1 by a CMOS switch (such as the 4066) or a V-FET (such as the BS 170), omitting R3 and R4. Alternatively, a proper switching transistor, the BSX 20, also provides excellent results.

82564

43 infra-red remote control

the transmitter

A remote control system having 20 channels with analogue functions can only be realised with the use of special ICs. Any other method would require an enormous quantity of components. However, it is all very easy, thanks to Plessey who produce a range of ICs designed specifically for this purpose. Our designers selected three of these for the remote control system here. It is capable of transmitting no less than 32 commands when used in conjunction with the receiver and associated circuits.

The transmitter basically consists of a keyboard decoder IC, an output and transducer stage and a small battery. In much the same manner as a pocket calculator, the commands ordered by the keyboard are fed into a matrix. This is arranged in 4 columns and 8 rows enabling 32 keys to be used (32 junctions or cross-points). It must be pointed out here that only one key can be operated at a time or the IC will simply ignore the entry. The key command (one key pressed) is converted into a corresponding 5 bit binary code. No detailed description of codes or their allocation to the keys or matrix will be given here

but is available from the data source mentioned at the end of the article. The 5 bit code is transmitted by means of the infra-red transducer diodes D1 and D2. The code is in the form of a pulse sequence consisting of 6 equal pulses interspaced by 5 spaces or pauses. The binary data is contained in the pauses, a long pause for a logic '0' and a short pause for logic '1'. This is termed 'pulse-pause' modulation (PPM). The length of the pulses and pauses can be calibrated with the aid of the preset potentiometer P1. The relationship between a logic '0' and a logic '1' ideally should be 1.5 : 1. The pulse width is approximately 3 ms while the interval between two command words will be about 54 ms. The transmitter will radiate an infra-red light signal when the output at pin 3 of IC1 is 'high'. This will be a 15 μs pulse which can produce a current of up to 8 amps through T2 and the diodes. The IC also contains an electronic stand-by switch which will reduce the quiescent current consumption of the IC down to a minuscule 6 μA when not in use, that is, between key operations.

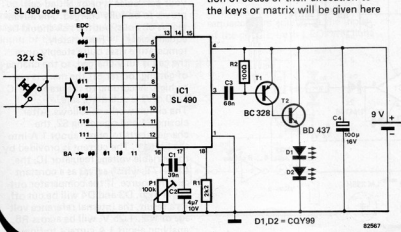

Reference: Remote Control Data, Plessey Semiconductors.

82567

44

high-speed NiCad charger

with temperature detection

In the Elektor December '79 issue the pros and cons of charging NiCads rapidly were discussed at length and two suitable circuits were put forward. The circuit here elaborates on the 'old' idea in order to produce something new . . .

The graph in figure 1 shows what happens during a (fast) NiCad charge cycle. At first, the voltage rises very quickly from its initial 0% charge to attain as much as 1.42 V with a 25% charge level. After this point, the voltage will tend to rise more gradually. Just before the fully charged level is reached, the voltage surprisingly surges once more.

In the first of the two fast charger circuits published in the December '79 issue, the rise in voltage was used as a parameter for monitoring the charge cycle. In the second circuit, however, a similar system was used to interrupt the charge cycle when the battery was 'overcharged' by about 20%. The manufacturer assures us that this cannot damage the battery.

As figure 1 shows, the gas produced when the battery is about 75% charged, causes a dramatic increase in the pressure and temperature inside the battery. By using the temperature curve relative to the charge, a simple procedure involving two special temperature sensor ICs serves to switch off the supply current when the temperature of the battery has risen

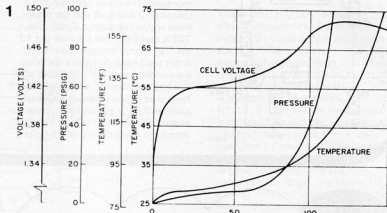

by 5°C. As can be seen in the graph, this is fairly conservative: an almost 'dead' battery will be charged to 50%, and even an almost 'full' battery will remain within the 20% overcharge margin.

Figure 2 shows the circuit diagram. The differential switch is similar to the one described in last year's Summer Circuits (no. 50). The output of the comparator opamp IC1 goes low whenever the voltage at its negative input is equal to that at its positive input. P1 sets the voltage level at the positive input so that it is 50 mV above that of the negative input. When the operational voltage is switched on (don't connect up the battery yet!) sensors D1 and D2 must be given enough time to reach the same

temperature. Depending on the temperature of D2, the voltage at the negative input will increase by 10 mV per degree °C. As D2 is mounted on top of the NiCad (preferably tightly strapped by a rubber band), the rise in battery temperature will automatically switch off the charge current.

A different voltage may of course also be set at the positive input. As illustrated in figure 1, the battery has only reached 50% of its charge level by the time the temperature has risen by 5°C, if it was initially completely discharged. However, there is a reason for this. The graph shown here can not be taken as 'gospel' for every battery and for all possible charge currents — and it is better to err on the safe side! There is an alternative, of course: you can progressively increase the temperature difference that the circuit will tolerate before cutting off, until your particular type of NiCad cell proves to be fully charged. The advantage is obvious, but the risk should be equally clear . . . Fortunately, temperature rises quite steeply once the cell is fully charged, so the chance of getting too far off the mark is not so high. According to the graph, 12°C (120 mV) is still quite safe.

The circuit works as follows. After closing S1 and operating S2, the charger starts to pump about 1 A into the battery. The current is provided by the variable voltage regulator IC, the LM 317T, which serves as a constant current source. If the comparator output is high, D3 and D4 will be cut off. As a result, the internal reference voltage of IC2, 1.25 V, will be across R8, enabling about 1 A current to flow

2

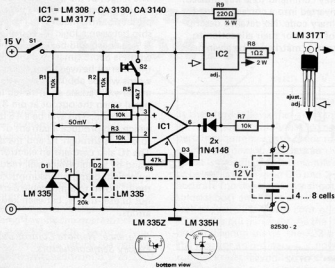

into the battery. Should, on the other hand, the comparator output be low, the cathodes of D3 and D4 will be practically grounded. The constant current source is switched off, and only 15...40 mA maintenance current will be flowing across R9 (depending on the battery voltage). The time required to charge a battery can be derived from its rating: a 0.5 AH cell in approximately 30 minutes, for

instance. In principle, the charge current should be related to the battery capacity and in practice this means that the circuit can cater for 4...8 AA penlight cells. Larger cells, such as the A and C types, can be charged, if an additional current source with the same component values is connected in parallel to IC2/R7/R8. 9 V compact batteries can be charged if R8 is increased to 6.3 Ω

(4.7 + 1.5).

One further hint: The rapid charge procedure will only benefit specific battery types (as indicated by the manufacturer). The circuit may have to be modified for each type by changing the value of R8, accordingly.

National Semiconductor

45

logic probe

instant logic level indication

The circuit diagram shows perfectly clearly that T1 together with R3, R4, D5 and D6 constitute a current source for LEDs D3 and D4. As a result, the current to the LED will be approximately 12 mA, irrespective of the operational voltage. The LED cathodes are grounded by either N1 or N2 enabling.

The LEDs are switched on and supplied by a constant current. The circuit's other task depends on the voltage applied to the disconnected end of R1. If, for instance, a relatively high voltage with respect to the ground potential is applied, N1 will invert the 'high' level, grounding the cathode D3. D3 lights to indicate a logic '1'. But D4 remains unlit, as its cathode is 'high'. It won't light until a very low voltage (less than 1/3 of the supply signal) is applied to R1, in which case the 'low' level will be inverted twice before reaching the cathode of D4. R1, D1 and D2 protect the circuit against an input overload.

The high-impedance 10 M Ω input resistor (R2) limits the load to the circuit under test. It also cuts off the input of the first inverter N1 when

1

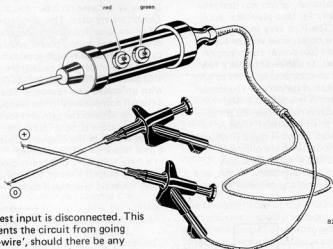

82529

the test input is disconnected. This prevents the circuit from going 'hay-wire', should there be any interference at the input.

All the components combine to form a very effective, straightforward logic probe for TTL and CMOS signals. In TTL circuits, the logic levels displayed by the tester do not quite match their exact definition, but it should be adequate for a rough estimate. Incidentally, when pulse sequences are applied at the input of the circuit, both LEDs will light

irrespective of the corresponding frequency. In other words, they will be lit continuously in most cases.

The logic tester does not require its own power supply, as it operates on an 'automatic level matching' basis. That may sound complicated, but that is exactly what it does! What happens is that the operational voltage is derived from the circuit being tested. As a result, the logic probe will always respond correctly to the level in force at any particular moment.

The entire circuit can be housed in a plastic tube or even in the plastic holder of a ballpoint pen. The test 'pen' is provided with a probe at one end and two connection wires including clamps at the other. Once the two clamps are connected to the power supply of the circuit-under-test, the probe merely has to touch a test point for the LEDs to instantly indicate the correct logic level at that point.

2

D1,D2,D5,D6 = 1N4148
N1,N2 = 1/2 IC1 = 4049

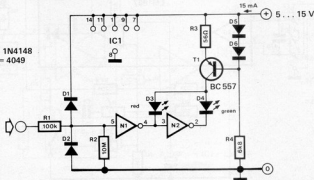

46

high quality tape playback pre-amp

... in stereo

Letters from readers together with the numerous comments expressed during the last Breadboard exhibition showed that there was a large demand for a low cost tape playback pre-amp.

Readers either wanted to improve the quality of their existing low cost recorder, or to build an auxiliary deck using one of the easily available drive mechanisms. In both cases the extra deck would be very useful especially for tape copying.

The circuit is constructed using a new, low cost IC from National Semiconductor, which was designed specifically for tape playback applications. The IC is very interesting due to its low noise, wide voltage supply range, and low power consumption properties. It also requires very few external components in order to construct a complete circuit. The distortion factor is less than 0.1% at frequencies ranging from 20 Hz to 20 kHz, at an output of 1 V_{rms}. The printed circuit is quite small and can be mounted easily onto any cassette chassis. A power supply delivering approximately 10 mA, at a voltage of anything between 10 and

16 V is sufficient.

The circuit is compatible with the noise reduction circuit (DNR), published in our March 1982 issue.

The circuit.

The LM 1897 is a dual gain pre-amp for any application requiring optimum noise performance. It combines the qualities of low noise, high gain, with good power supply rejection (low Hum) and transient free power up! No 'power up' transients are achieved primarily because no input coupling capacitors are used. This eliminates the 'click' or 'pop' from being recorded onto the tape during power supply cycling in tape playback applications. The omission of these capacitors also allows a wide gain bandwidth with unlimited bass response. The external components in the feedback loops, determine the gain and form an equalisation circuit. Using the values shown in the diagram (figure 1), a gain factor of 200 is achieved at a frequency of 1 kHz, corresponding to an output level of 100 mV_{rms}. Most available tape heads should

give results of this kind. The equalisation time constants are 3180 and 120 μ s for ordinary low noise cassettes. For all other types of tape, such as ferro chrome and chromium dioxide, the defined constants are 3180 and 70 μ s, in which case the two R4 resistors are replaced by 33 k Ω ones. Constructors not wishing to use the muting option, can leave out switch S1 and the two R7 resistors. Screened two or four way cable should be used to connect the circuit to the tape heads. The choice is up to the constructor, but please keep in mind that if two way cable is used the screening sleeve is to be connected to the ground of the printed circuit board.

A good ground connection between the printed circuit board and the drive chassis is also essential!

power supply

An unbalanced, filtered D.C. voltage of between 10 and 16 V will be sufficient for the circuit because of the high power supply rejection (low

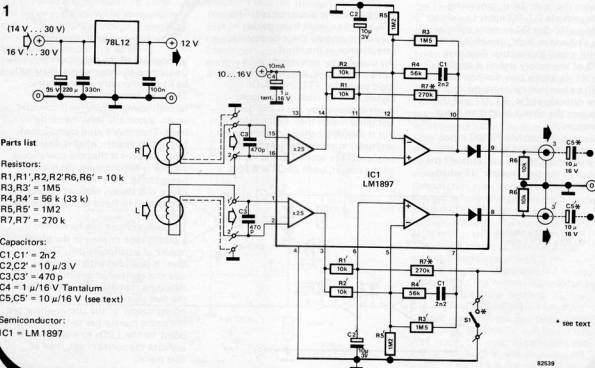

2

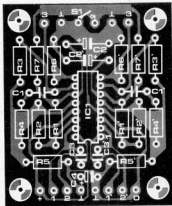
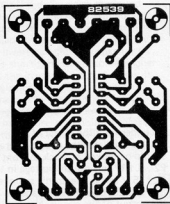

hum), of the IC. Batteries can also be used successfully. A voltage regulator such as the 78L12 is required only when the available supply is unfiltered or likely to be 'noisy'.

The output of the pre-amp has not been decoupled since virtually every power amplifier contains some type of input coupling capacitor. Constructors who are in doubt about this fact can insert capacitors C5 and C5', as shown in the circuit diagram. The pre-amp has a low output impedance. This should not present any problems as the input impedance of most amplifiers and other 'HI FI' equipment is around 1 kΩ.

47

square triangle VCO

with dual waveform output

This voltage controlled oscillator (VCO) is capable of providing a triangular as well as a squarewave output signal. As with any other VCO, the frequency of the output signal depends on the level of the control voltage (U_C). Remarkably, this design features a wide control voltage range; between 0 V and the positive supply voltage. The power supply voltage can be anywhere in the region of +3 V to +25 V. However, care should be taken when using low voltage supplies that the maximum output level is at least 1.5 V below that of the supply.

The circuit is based on the 'integrator — comparator' principle. Capacitor C1 is part of the integrator (constructed around opamp A1) and is charged by a constant current level determined

by the instantaneous level of the control voltage. Consequently, the output of A1 will fall linearly. The output of the comparator (constructed around A2) will change state and transistor T1 will start to conduct when the lower switching threshold of the comparator is reached. Capacitor C1 is now discharged causing the output of A1 to rise (again, the voltage rise will be linear). This process will be repeated when the output of A1 reaches the upper switching threshold of the comparator and T1 is turned off.

The duty cycle of the output signal will be 50% when the values of R2 and R3 are the same and when the value of R1 is twice that of R4 (R2 = R3 and R1 = 2 × R4). The relationship

of the values of resistors R9 and R10 determines the DC level of the triangular output signal. With the values indicated in the circuit diagram, the DC level will be half the supply voltage. The peak-to-peak output level

$$(V_{pp}) \text{ is equal to } \frac{R5}{R5 + R6} \times U_b.$$

The characteristics of the VCO with two (common) supply voltages are shown in figure 2. The maximum frequency (when $U_C = U_b$) supplied by the circuit can be increased or decreased by selecting a lower or higher value, respectively, for capacitor C1. Due to the slow rate of the opamp, the steepness of the squarewave signal will fall off at higher frequencies.

1

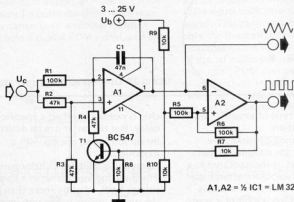

A1, A2 = 1/2 IC1 = LM324

2

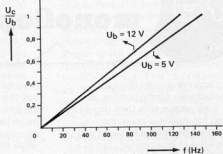

82521-2

48

graphic oscillator

waveform mixer

'And we don't mean graphic equaliser'. An oscillator operating along similar lines to an equaliser. In the case of the latter, a set of slide potentiometers adjust the frequency response and the

level can be directly deduced from the position of the levers. Here slide potentiometers are used as well, only now for the purpose of setting the waveform on the screen.

To understand the object of the graphic oscillator the circuit diagram should be looked at 'back to front'. P2...P17 sets the DC voltage in the 0...5 V range. Electronic switches ES1...ES16 feed the voltages to the output of the circuit. Normally speaking, the article should end here, were it not that the circuit has an additional interesting feature to offer...

When an oscilloscope is connected to the output, a waveform appears on the screen that can be adjusted to contain up to 16 steps. Fortunately, this does not have to be done manually for the remaining components produce a constantly repeated switch cycle. The counter IC8 provides a 'bit' pattern at its outputs to the rhythm of the pulses generated by IC9. The bit pattern, decimal numbers 0...15 in binary, drives the multiplexer IC7, so that its output goes 'low' whenever the input data is addressed to the output concerned. For example, where A = high, B = low, C = high and D = low, output 5 = low.

Since a logic one inhibits the electronic switches, 16 inverters are required to make sure the right DC level reaches the output. By adjusting P1 and C1, the clock frequency can be set to a very wide range. Where $C1 = 1 \text{ n}$, theoretically: $f = 123 \dots 710 \text{ kHz}$ and where $C1 = 10 \mu$, $f = 123 \dots 710 \text{ Hz}$.

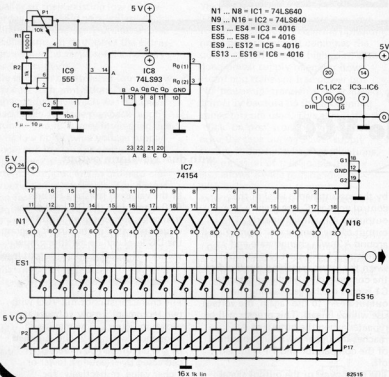

49

analogue monoflop ...

... using an opamp as a comparator

Monoflops are automatically associated with digital circuits, but there is no reason why they should not be used for analogue purposes.

Obviously, the opamp involved will not be used as an amplifier, but as a comparator. The 741 is implemented in both of the circuits shown here, although, as a matter of fact,

practically any type of amplifier will suit this application.

Modern IC technology makes life much easier for the designer in that four opamps can be incorporated in a single tiny package. More often than not, however, one of the opamps is not required, which is a bit of a waste, and what's more, an additional digital

chip is needed to effect a specific time delay. But the latter can be omitted by combining an opamp with a monoflop.

Operation is quite straightforward. The inverting input is set at a fixed voltage level, (slightly more than half the supply voltage). The non-inverting input is grounded by R5 and P1. The

output is therefore also at ground potential and diode D1 will not conduct. When a positive pulse is applied at the input, it is fed to the non-inverting input by capacitor C1. For a short time this becomes higher than the inverting input. As a result, the output of the opamp will be connected to the positive supply voltage. Diode D1 will now conduct and make sure that point A remains positive even when the input signal is no longer applied. This situation

will not change until capacitor C1 is charged by way of R5 and P1 and the voltage at pin 3 is lower again than that at pin 2. The opamp will then 'flip' over, its output being grounded once more.

In principle, the same procedure applies to the negative response circuit. As can be seen in the pulse diagrams, the input signal should be either longer or shorter than the required output signal. The resultant mono time is around

$0.5 (R5 + P1) \cdot C1$. P1 sets the exact value, which is determined, to a certain extent, by the saturation of the opamp output, and so can only be calculated approximately.

Just make sure that the input signal is always slightly smaller than the variation in amplitude at pin 6, because the signals might affect each other, especially if the input and output pulses have the same duration.

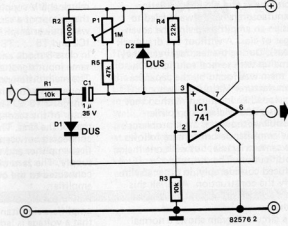
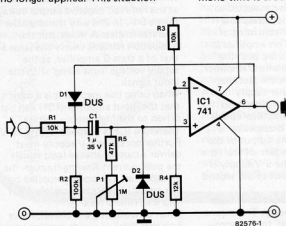

50

the simplest PDM amplifier

pulse duration modulation

The term PDM merely stands for pulse duration modulation. A PDM amplifier consists of a pulse duration modulator, which converts an analogue audio signal into a digital PDM signal, and an

amplifier connected to an integrator which together convert the amplified PDM signal back into an analogue signal. This particular circuit is probably the most straightforward PDM amplifier in the world. In the wake of digital audio technology 'break-throughs', PDM devices (or digital amplifiers) are rapidly gaining popularity. Some Japanese manufacturers are even including PDM technology

in their current ranges of stereo amplifiers equipment.

The circuit described here is based on the fact that the transmittance curve of a buffered (B version) 4066 CMOS switch is extremely steep. As a result, the device can be used to reliably obtain a high gain factor. The circuit shown to the right of the figure represents the analogue equivalent of the PDM circuit. This corresponds to an inverting analogue amplifier, which unfortunately has a rather high distortion factor thereby making it totally unsuitable for hifi purposes. The gain of the circuit using the component values shown is 10. A gain of 100 can be achieved if the values of the components marked with an asterisk are altered to 1 MΩ and 1 n.

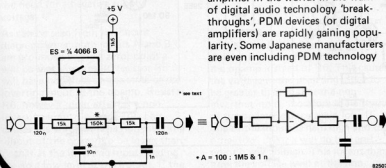

52

omnivore LED

not fussy about voltages

Ordinary LEDs have a rather monotonous diet: they will only 'swallow' DC current with the right polarity, in which case a series resistor cuts down the current appetite to a moderate 10...30 mA. This type of provision

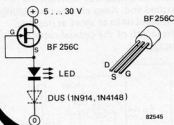

has a drawback in that the value of the series resistor must be calculated for each separate supply voltage, and that fluctuations in the supply signal can only be handled within a limited range.

Substituting a FET for the series resistor affords a number of advantages. When the gate and source are linked, the transistor forms a current source without the need for any additional components. In the type used here, the BF 256C, the constant current is between roughly 11 and 15 mA, with a wide supply range of 5...30 V. A universal silicon diode (DUS), such as the well known

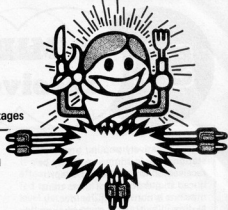

1N4148, will provide polarity protection when connected in series with the LED. As a result, the 'Omnivore' LED can be driven with AC voltages in the 5...20 V (= 7...30 V) as well. At the normal 50 Hz mains frequency, the LED will barely flicker at all, except that its brightness will be a little dulled due to the half-wave rectification, compared to that at an equivalent DC voltage level.

53

EX(N)OR opamp

an analogue digital gate

Nowadays, digital techniques are finding their way into more and more analogue circuits. Fortunately, this does not always call for the use of special integrated circuits, as it is quite common to see opamps being used to provide the logic functions NOT, AND, NAND, OR and NOR.

However, this does not (normally) apply to the logic functions EXOR and EXNOR. Nevertheless, the latter can be obtained by using LM 324 or LM 358 type opamps. These opamps have the advantage that their outputs can be driven to 0 volts without the need for a negative supply voltage.

As can be seen from the circuit diagram, when both inputs A and B are grounded (= logic zero) point a will be low. As a result, resistor R5 will have no effect on the state of the inverting input of the opamp. Resistor R6, however, does affect the non-inverting input via diode D2. This causes the voltage at the non-inverting input of the opamp to be lower than that at the inverting input, leading to a low level at the output. If the

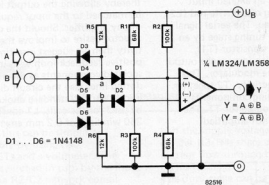

A. Rochat

two inputs A and B are taken high (= supply voltage), point b will also go high via diodes D5 and D6. Thus, resistor R5 now affects the state of the opamp instead of R6. This causes the voltage at the inverting input to be greater than that at the non-inverting input, therefore the output of the opamp is once again low. If one of the inputs is held high and the other low, point a will go low and point b will go high. This means that now the voltage level at the non-

inverting input will be greater than that at the inverting input, resulting in a high voltage level at the output of the opamp. In other words, a genuine EXOR gate! The EXNOR function can be obtained very easily indeed. Simply swap around the inverting and the non-inverting input connections. Now the output of the opamp will go low whenever the two input levels are different and will go high when the input levels are the same.

54

a 'MID-FI' receiver

a medium fidelity receiver for MW and LW

Several relatively popular broadcasting stations can, in some areas, only be received on MW or LW. The reproduced sound quality of these transmissions is normally quite low.

Nothing like HI-FI is normally possible because of the limited bandwidth of transmissions. However a greatly improved sound quality is possible, obtained quite easily by using just a few widely available components. The improvement is so remarkable that it can be noticed distinctly. The outstanding feature of this receiver is its unconventional concept. The tuning stage of the receiver also serves as an active aerial, which can be favourably placed in order to get the best possible reception. Furthermore it is completely separated from the rest of the receiver, that is from the demodulator supplying the AF output. This part can be inserted into a separate housing, and placed next to an amplifier or the HI-FI equipment. The interconnection between the two parts should be made using standard coaxial cable. This cable feeds the RF signals and the tuning voltage (which is the operational voltage of the aerial) to the modulator. The plastic aerial housing contains an aligned input circuit, consisting of a ferrite rod (L2), and double varicap. The aerial signal is coupled to the tuning stage by an emitter/follower transistor (T1), ensuring that a high impedance output signal is fed to the modulator. This improves the selectivity. T2 together with its surrounding components forms a current source for T1. The received signal is not amplified

whatsoever in the active aerial stage, but in part of the TBA120 IC which forms part of the modulator. L2 serves as an emitter decoupler for T1. L3 decouples the supply and tuning voltage thereby short proofing the RF output of the active aerial. L4 effectively doing the same for the demodulator. P1 can either be a trimming potentiometer allowing preset tuning of a particular station or a multi-turn (helical) type for normal variable tuning. TBA120 IC is the amplifier and quasi-synchronous-demodulator for the signal fed from the active aerial. Apart from the unusual method used for modulation, the receiver follows the standard 'straight-through' principles having a good signal-to-noise ratio.

Unfortunately the main disadvantages of this design is that it suffers from bad selectivity and low sensitivity. Consequently the constructor should not expect the receiver to work miracles, especially during the evening hours or when trying to tune in to distant stations. However for most relatively local stations it will perform well.

Potentiometer P2 sets the gain of T3, thereby allowing the output level to be matched to the input requirements of any amplifier. Should the constructor desire to improve the selectivity then we suggest inserting a positive feedback loop with its associated components as shown by the dotted lines (see the circuit diagram). Except for L1, standard chokes can be used for the coils. L1 consists of 250 windings of 0.2 mm enamelled

wire for LW and 80 turns of 0.3 mm wire for MW, wound onto a ferrite aerial approximately 20 cm in length with a diameter of 10 mm. The extra positive loop should be connected by tapping into the coil approximately a quarter of the way up from the earthed end. Keep all interconnecting wires and links as short as possible. The length of the coaxial cable is not critical.

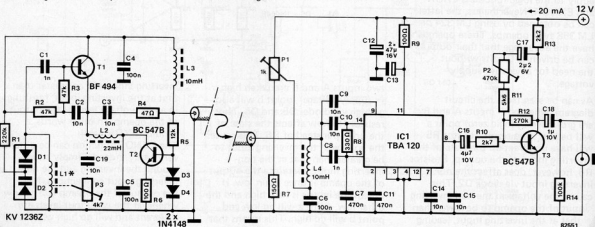

* see text

82551

55

low cost temperature indicator

one LED per degree C

The novel use of components in this electronic temperature indicator make it very simple and economical to build. It uses only three ICs, an LM335 temperature sensor, a 723 (old faithful) voltage regulator and a TL489 five stage analogue level detector.

The temperature sensor (IC1) is supplied with a constant current from the reference output of the 723 (IC2). This provides a stable zero point setting enabling accurate readings to be achieved. The circuit around the 723 is arranged to allow the output of the regulator to vary

between zero volts and one volt. It also acts as an amplifier with an effective gain of 20. The output is fed to the input of the analogue level detector IC3. Depending on the voltage level at its input, this IC will light one or more of the LEDs D1...D5. Since the sensitivity of the sensor is 10 mV per degree centigrade (10 mV/°C), and the gain of the 723 is 20x, it follows that the TL489 requires an increase in voltage level of 200 mV at its input to light each successive LED. Therefore, one LED will light for every 1 degree rise in temperature registered. Calibration is very straightforward. The temperature measuring range (or temperature 'window') is set by P1. For example 18...23°C (5°C). This range can be altered if desired by simply changing the values of resistors R6 and R7. For two degrees temperature change per LED, the resistor values must be 100 kΩ.

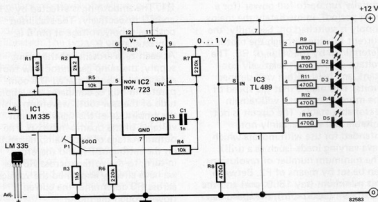

56

duty cycle meter

direct duty cycle measurement

The duty cycle of a square wave signal is normally measured by means of a pulse counter or an oscilloscope.

However, this can be simplified considerably by using two VMOS-FETs and a voltmeter. The FETs are switched in turn by the input pulses. The R2/C2 network combination provides an average DC level corresponding to the input waveform:

$$U_{av} = T/r \cdot U_b$$

The meter reading can be interpreted as follows: The indication of the duty cycle can be expressed as a percentage (link A). For link B, a voltmeter with a centre zero is preferable. A DVM would also do the trick, but not quite as well.

The voltage level at the input of the meter will be half the supply voltage when the duty cycle is 50%. Since the other side of the meter is connected to

half the supply voltage (via voltage divider R3/R4) there will be no current flow through the meter (hence a zero reading).

The duty cycle can be read directly in % if the scale is divided into 1...10 ($U_b = 10$ V) and the centre point (5) marked as 50%.

An important note: It is imperative to ensure that the input waveform switches abruptly between a low level (less than 0.8 V) and 'high' ($U_b - 0.8$ V or higher). Between these values both FETs would start to conduct, thus causing a short circuit across the supply voltage source. Moreover, the maximum supply voltage must not be exceeded. One final remark: The internal resistance of the meter must be at least 100 kΩ.

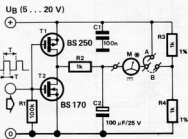

* see text

82568

57

A.C. motor control

motor control for squirrel cage motors

This circuit makes it possible to control the speed of single phase motors with squirrel cage. This is not to say that every motor can now be made to run at any desired speed, but, that a speed range to a factor of 2 should be readily obtainable with suitable motors. That is to say that the range is from half to full speed. This range may not seem to be much, but, for fans, pumps and other equipment of this nature, it is quite a useful range. It can conveniently reduce both the current consumption, and noise levels of this type of appliance.

The circuit described here makes use of an SGS Ates IC that was specifically designed for phase control. An asynchronous (short circuit rotor) motor has two windings, their magnetic fields being at 90° to each other. One winding is connected directly to the mains, the other via a capacitor to ensure that the current passing through one winding is out of phase to the other. This invariably results in a rotating magnetic field, enabling the

motor to run.

Only the winding which is connected directly to the mains supply needs to be controlled, by what could be termed as a standard type of triac speed control.

There are two main points to note. Firstly, irrespective of the speed setting of the controller, the motor will initially run up to full power (for a brief period), immediately the mains supply is switched on. Secondly, the current flowing through the motor is determined by the value of R8. The voltage across R8 is relatively constant, and held within well defined limits. This means that the speed of the motor (once set), will remain reasonably stable. The circuit is not suitable and was certainly not intended for use with motors which have varying loads (such as a drill). The minimum number of revolutions can be set by means of P2. Between this minimum (say 1800 rpm) and the maximum (3000 rpm), the speed can be controlled by P1. The circuit was

designed to handle up to 90 W. Higher powered motors are possible but then R8 will have to be changed accordingly.

The IC deserves a special mention. Looking closely at the circuit diagram, you will notice that box 1 of the IC derives a negative and positive supply voltage of 11.5 V from the mains, via R1. The smoothing is effected by C1 and C2 respectively. The stabilised positive supply voltage at pin 6 is approximately 9 V.

At each zero crossing of the mains supply, the ramp generator (saw tooth oscillator) in box 4 starts. The comparator in box 5, compares the amplitude of the saw tooth waveform with the amplitude of the signal (output voltage) of the opamp in box 6. The output voltage of the opamp depends on the setting of P1, and therefore in turn, to the voltage across R8. As we have already explained the voltage across R8 determines the current flow through the motor.

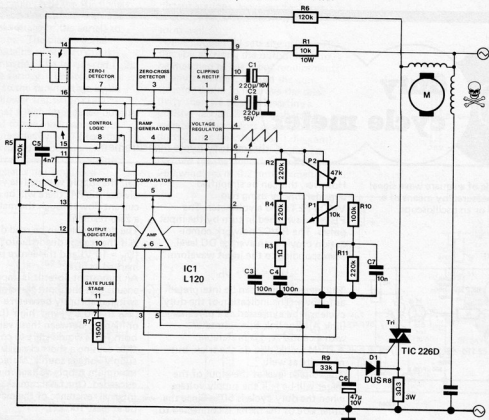

58

pulse generator

... adjusts the duty cycle in precise 1% steps

With the aid of this circuit, the duty cycle of a signal may be adjusted very accurately in 1% steps within the 1% ... 99% range. At the same time, it is possible to keep the frequency of the output signal completely independent of the duty cycle setting. Accurate pulse generators are needed whenever a meter or a circuit that calculates the level of a signal on the basis of its duty cycle and evaluates and/or processes the signal to be calibrated. The type of circuits in mind are remote control (PPM) and phase cutoff angle meters.

The pulse generator in figure 1 can be constructed quite easily using three CMOS ICs. The decimal counters IC1 and IC2 are connected as divide-by-tens. Flipflop N2/N3 is set via R1/C1 upon the falling edge of the Q₉ signal of IC2 (which corresponds to the rising edge of Q₀!) and the Q output of the circuit goes high. The intermediate count reaches gate N1 via the select switches S2 and S3. As soon as the required count is attained, N1 sends a reset pulse to the flipflop and the Q output goes low.

Figure 2 shows what happens in the form of a pulse diagram. The clock signal may well be transmitted by an

1

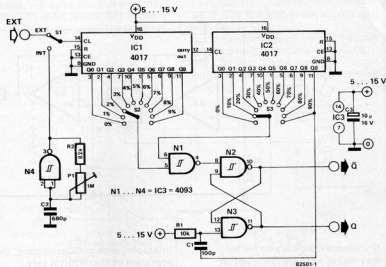

external device. As it is divided by ten twice, the output frequency will be 10 kHz at a maximum input frequency of 1 MHz. Alternatively, the internal oscillator may be switched on via S1, in which case an output frequency of between 20 Hz and 200 Hz, approximately, (variable with P1) will be

obtained at an operational voltage of 12 V. The preset range may be adjusted by altering the operational voltage (within the 5 ... 15 V range). In addition, the frequency range may be varied by selecting a different value for C2.

Back to the pulse diagram. By way of an example, a duty cycle of 12% has been set here (see figure 1). Initially, the set pulse makes Q go high. But as soon as Q₂ of IC1 and Q₁ of IC2 are high, Q will go low again, etc. Supposing we wish to set the dwell angle of a 4 cylinder engine, we will have to take the following into account: the dwell angle is defined as a certain period of time, during which the contact breaker connections are closed. This corresponds to the time interval during which the signal is low. Thus, the definition of the dwell angle is the exact opposite of that of the duty cycle! What all this boils down to in this particular application is that the maximum dwell angle is 90°. This may be adjusted to, say, 54°. As a result, the variable duty cycle will be:

$$\frac{(90^\circ - 54^\circ)}{90^\circ \cdot 100\%} = 40\%$$

2

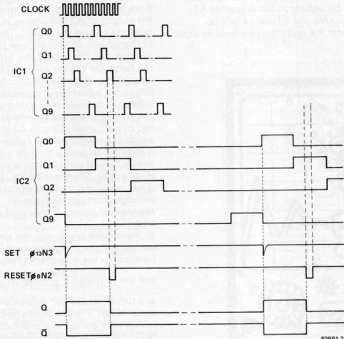

59

oscilloscope aid

display data point connector

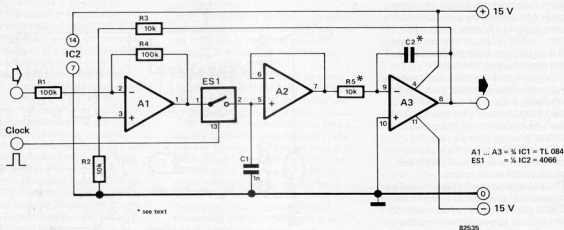

If analogue signals are converted into digital and then displayed on an oscilloscope it will be obvious that the legibility will be less than perfect. This is due to the fact that the display consists of a (sometimes) large collection of short horizontal lines which can appear to have little or no relation to each other. Interconnecting these 'dashes' will make the displayed information far easier to read and this circuit was specifically designed for this purpose. It produces a fairly complex 'waveform' on the screen but nevertheless, the legibility is considerably improved.

In keeping with most good ideas, the operation of the circuit is very straightforward. An initial requirement is a clock signal that becomes a logic '1' whenever the displayed data jumps to a new value. This can be derived from the circuit under test with the aid of a monostable. Opamp A3 is designed as an integrator which serves as a memory. If the incoming voltage level does not correspond to the voltage level at the output of A3, the difference between the two levels will be present at the output of A1. Obviously the difference will be greater the more the new level deviates

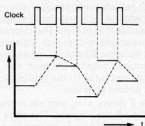

from the previous value. Consequently the output of A3 will change in an attempt to correct the 'error'. The rate of change will depend on how big the difference is, the greater the 'error', the faster the change will be at the output. Providing the R5/C2 combination has been chosen correctly, the difference between the input and output voltage levels will be zero at the end of each cycle. Opamp A2 is simply a high impedance voltage follower and is included to ensure that the voltage level across C1 remains stable between clock pulses. Strictly speaking, ES1 is not really required but without this switch the output would be an exponential curve which would reduce legibility.

As mentioned previously, the time constant of the integrator must be identical to the data change frequency

and the formula $f = \frac{1}{RC}$ can be used

as a rule of thumb for determining these values. The circuit can be calibrated with the aid of a preset connected in parallel with R5 if desired.

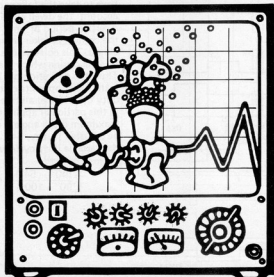

60

mini EPROMmer

the simple programming circuit

Fortunately the prices for widely available EPROMs is falling considerably. It might therefore be worthwhile to construct complex logic functions with EPROMs instead of the normal digital ICs (gates, flipflops, and so on). This would make the construction of the circuit much more compact and straightforward.

The EPROM 2716 contains 11 inputs (address lines A0 . . . A10) and 8 data lines (D0 . . . D7), which are connected as inputs during programming and as outputs for other functions. Therefore it is possible to program complex logic functions. For example a programmed EPROM can be used as code converter. This leaves us with the problem of finding a suitable programming device. It is rather expensive to build or buy a programmer, if it is only to be used occasionally.

In this case a straightforward circuit will suffice, with which the associated data of the logic functions can be stored in the EPROM quite easily. The circuit described in this article offers this possibility. Any program can be programmed step by step with the aid of this circuit.

There is one crucial point which has to be considered, when using EPROMs and that is the access time. The operation speed of the complete circuit depends on it. The circuit must be constructed in the conventional manner, using gates, flipflops and so on, if the EPROM is too slow, due to the access time, for a certain application.

The next question is what is to be programmed? First, switch S21 must be set to position 'b'. In this case, pin 21 of the EPROM will be connected to the programming voltage and the data connections D0 . . . D7 are connected as inputs. The corresponding data can now be set bit by bit by means of switches S1 . . . S8. An open switch then stands for logic 1. After that, the corresponding addresses can be set with the aid of switches S9 . . . S19. Again an open switch denotes a logic 1. Once the correct data and address bits have been selected, depressing S20 is sufficient to transfer them into EPROM. The LED D9 lights to indicate the programming time.

Obviously some form of check is necessary, when the complete program is stored in EPROM, because the readers who have programmed

by hand, will agree that it is very easy to make an error. Switch S21 in position a, in order to check the program.

The LEDs D1 . . . D9 will now indicate which data is stored in the address set with S9 . . . S19.

A stabilised voltage of 5 V and 400 mA will be enough to supply the circuit, and a 30 V at 30 mA supply is sufficient to produce the programming voltage.

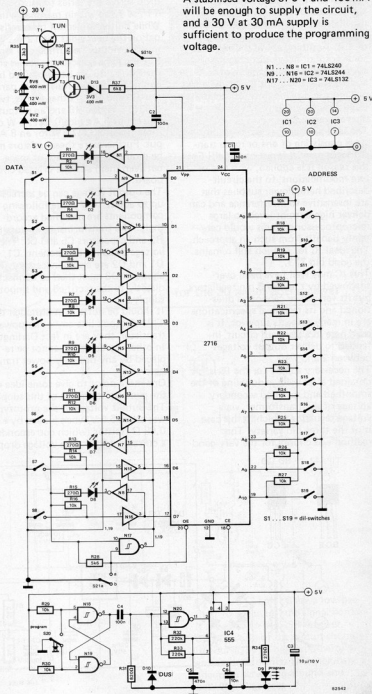

61

5 V super power supply

power to the micro people

The subject of power supplies seems to be of little interest since the introduction of the well-known 3 pin voltage regulator ICs. However, the usefulness to the average home constructor is usually restricted to the versions that can deliver up to a maximum output of 1 A. Anything above this requires some form of heavy duty regulator stage. Regulator ICs capable of 5 A and 10 A do exist, but it usually works out more economic for most people to go straight into some form of discrete regulator.

The idea of adding a power output stage consisting of one or more transistors in parallel is not bad at all! For this reason it is applied, with one or two modifications, to the circuit described here. Power supplies that are insensitive to interference and can deliver high current levels to large microprocessor systems would certainly benefit from such an approach. The ideal IC for this job still remains the good old 723.

This IC may well have been overshadowed by the new 3 pin regulators, but its versatility cannot be questioned and its technical specifications are in many respects superior. It is used here in a standard circuit, intended to deliver output voltages between 2 and 7 V.

The necessary supply for the IC is obtained after voltage doubling of the smoothed and rectified secondary voltage of the transformer, via a voltage regulator, which in this case is of the three pin variety. This method was chosen for the very good

reason that the secondary voltage of the transformer must be kept as low as possible, in order to hold the power drop across the series transistors T1 ... T3 to within reasonable limits. While on the subject of power dissipation the heat sinks for T2 ... T3 must obviously be sufficiently large. For the same reasons the values shown for R4 ... R6 are best obtained by connecting several resistors in parallel. For R4 and R5 in other words, twice 0.33 Ω 5 W, for R6 and an output current of 6 A twice 0.22 Ω 5 W or three times 0.33 Ω 5 W for an 8 A output. Furthermore these resistors must be mounted with plenty of space between them and the printed circuit board.

The output voltage can be increased up to about 14 V if the following components are modified accordingly. The transformers, resistors R1, R2 and capacitors C5 and C6. The voltage doubling components C1, C2, D1 and D2 are also unnecessary. The anode of D3 must then be connected directly to the rectified and smoothed supply.

It should be noted that although the TIP142's look like any other power transistor, they are in fact Darlingtons. In other words, they cannot be replaced by any ordinary power transistors.

One more point to give some idea of the good performance of this supply. The output voltage of the prototype was set at 5.5 V when loaded by a 0.68 Ω resistor (which corresponds to a current of 8 A). The voltage dropped

to 5.32 V! This is a drop of 3.3% at 7.8 A. Furthermore, under the same conditions the ripple was less than 25 mVrms.

Parts list:

Resistors:

R1, R2 = 3k3
R3 = 100 Ω /1 W
R4, R5 = 0,15 Ω /5 W*
R6 = 0,1 Ω /10 W*
P1 = 5 k preset

Capacitors:

C1, C2 = 470 μ /50 V
C3 = 220 μ /50 V
C4 = 1 μ /16 V
C5, C6 = 1000 V μ /25 V
C7 = 10 μ /16 V
C8 = 470 p

Semiconductors:

B = 10 A/40 V bridge rectifier (not p.c.b. mounting)
D1 ... D3 = 1N4001
T1 = BD 139
T2, T3 = TIP 142 (Darlington)
IC1 = 7812
IC2 = 723

Miscellaneous:

Tr = 10 V/10 A toroidal transformer
S1 = double pole mains switch

* see text

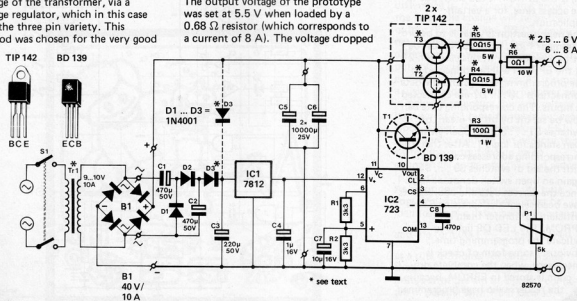

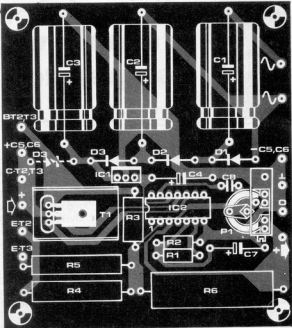
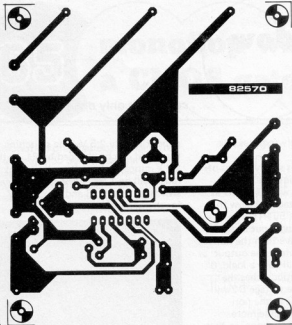

62

short wave converter ...

... for the 20 meter SSB receiver

A descriptive and constructional article for an SSB receiver was published in the June issue of Elektor.

The intention was to encourage readers to construct this type of equipment. It was mentioned at the time that the basic design could be used as the basis for other amateur bands providing a converter was available. This means that the receiver frequency must be mixed with an oscillator signal in such a way that the output is tuneable in the range of 14 ... 14.35 MHz. The oscillator frequency together with the special component values required for the specific amateur band required are given in the table.

The circuit itself consists of three sections; the input stage (VLF), the oscillator T2 and the dual gate MOSFET mixer stage T1. Components

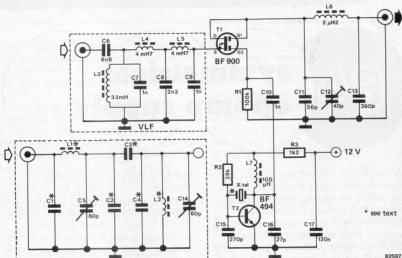

Table	Band	Frequency (MHz)	Crystal (MHz)	L1/L2 (µH)	C1 (nF)	C2, C4 (pF)	C3 (pF)
	VLF	10 ... 140 kHz	14.0	—	—	—	—
	160 m	1.8	15.8	2.7	3.3	180	33
	80 m	3.5	17.5	8.2	3.3	180	15
	40 m	7	21.0	2.2	2.2	180	10
	30 m	10	24.1	1	1.5	150	6.8

C11 ... C13 and L6 are a low-pass filter to 'clean up' the signal before it is passed to the SSB receiver. Construction of the circuit should, of course, be of highest quality to ensure best results. This includes adequate screening around and between the stages.

63

a simple window comparator . . .

. . . containing only one opamp!

A window comparator, also called window discriminator, examines whether a voltage is situated in the range ('window') between two given reference points. In this way, a window comparator can be used for various kinds of control circuits. For example, it can be used to indicate the oil temperature of an engine; The window comparator can show whether the temperature is in the tolerated (green) range or not, (after the oil temperature has been converted into a DC voltage).

Normally two comparators, an AND gate and at least two opamps are needed to construct a window discriminator. However, the circuit

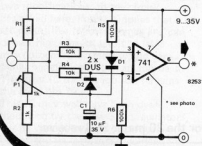

shown in figure 1 only requires one opamp!

A reference voltage is set by means of the trimming potentiometer P1. D2 will conduct and D1 will be cutoff as long as the input voltage is below this reference voltage (set by P1). The voltage at the inverting input of the opamp is more positive than the non-inverting input, therefore the output of the comparator will have a logic '0'. If the input voltage approaches the value of the reference voltage D2 will cutoff and the voltage at the non-inverting input will become more positive than the inverting one, so that the output voltage becomes logic '1'. D1 starts to conduct when the input voltage exceeds the reference voltage by 0.6 V. Consequently the voltage at the non-inverting input cannot increase, in contrast to the voltage at the inverting input which can. Increasing the input voltage further will make the inverting input more positive still, thus causing the comparator output to become logic '1' again. The window will be closed! With the values indicated in the circuit diagram, the 'window width' will be

approximately 2.5 V. The switching threshold can be changed by P1. With a 9 V supply voltage the adjustment range will be 1.5 . . . 5 V for the lower switching threshold and 4 . . . 7.5 V for the upper threshold.

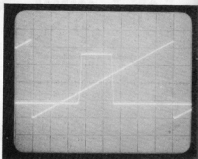

Photo 1 shows the sawtooth input signal, ranging from 0 to 9 V, and the output signal of the comparator. This picture clearly indicates that the 741 at the output cannot switch through to 0 V and $+U_b$ completely. When $+U_b = 9\text{ V}$ the logic '0' output voltage will approximately be 1.9 V and the logic '1' output voltage will be about 8.5 V.

64

symmetrical opamp supply

from a single battery source

A simple and well-known circuit: a symmetrical supply constructed *with* an opamp *for* opamps and of course other small circuits that require a positive as well as a negative supply voltage. Both voltages are derived from one battery. The resistors R1 and R2 form a high impedance, and therefore energy saving voltage divider. The opamp takes care that the artificial ground potential remains identical to the potential at the junction of R1 and R2. The relationship between the two output voltages; if R1 and R2 have the same value, the same will hold

good for both output voltages (symmetrical). This brings us to the most pleasant characteristic of the circuit, in that the relationship does not depend on the battery voltage! Another advantage of this active voltage divider is the fact that (in contrast to a simple resistor divider chain) it adapts itself well to changing load currents passing to and from the earth potential, particularly in the case of unsymmetrical load current conditions.

There are various types of opamps that can be applied for this circuit. The 3140 and 324 are excellent, even with a battery voltage of 4.5 V. Bear in mind that the maximum tolerated

J. Wallaert

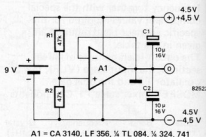

A1 = CA 3140, LF 356, 1/2 TL 084, 1/2 324, 741

load of the artificial ground depends on the opamp being used (normally about 20 mA)

65

monoflop with a CMOS gate

single gate monostable

A monoflop only has one stable state. When triggered by a pulse, the circuit 'flips over' from the unstable back into the stable state. The 'on-time' depends on the component values chosen for the RC network. As most constructors probably know, such a circuit can also be designed in quite a different way. A monoflop can quite easily be built using special ICs, but this circuit takes the idea one step further and is much more straightforward: it only needs a single gate!

In principle, a gate can be induced, (by applying a pulse to the input), to leave its quiescent state and return to it after a certain period. For this, a differentiating, in other words,

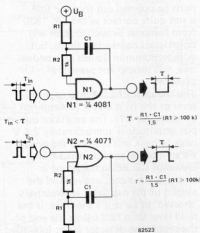

RC, network is required at the input, which at the same time provides the on-time for the gate.

Figure 1 shows two possible configurations for a single gate monoflop. They both have regenerative feedback. This considerably improves the steepness of the output pulse. For the circuit to operate properly, the input pulse must last less time than the anticipated output pulse (based on the component values). What's more, R1 must be at least 100 kΩ.

66

electronic thermometer

The scale of a thermometer used for measuring the temperature of liquids is normally graduated from 40°C to 100°C. The circuit described here operates within this range and uses the recently introduced KTY-10 temperature sensor from Siemens. The current produced (up to a maximum of 20 mA) is directly proportional to the temperature, allowing simple calibration without the need for

complicated calculations. The circuit can be used to measure the temperature of a number of things including; car oil, bath water, baby food etc. (but not all at the same time!).

As can be seen from figure 1, the electronic thermometer is made up of a bridge circuit consisting of resistors R1 . . . R3 and the sensor RT. The voltage across the bridge is stabilised by the zener diode D1. The bridge circuit is followed by an opamp, IC1. Any voltage difference at the input is followed and fed to transistor T1. This determines the amount of current flowing through the load circuit RL. This type of temperature to current conversion circuit is not affected by the overall resistance of RL and therefore the length of the connecting leads to RL is not critical.

The load circuit is in fact the display or indicator section. Either an analogue or a digital multimeter may be used. Preset potentiometer Rp should be adjusted so that the display section does not register temperature readings below 40°C.

The circuit can be used for other temperature ranges, if the values of resistor R1 and R2 are altered. If, for instance, the value of R1 is reduced and the value of R2 is increased, a lower temperature range will be obtained.

The value of R3 must, however, be reduced by 1 kΩ for each 25°C shift in the temperature range. Lastly, all the components should have a tolerance of 1%.

Siemens application note.

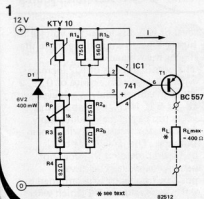

2

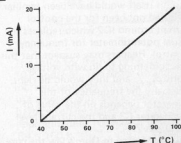

67

fluid level detector

with a choice of three level indications

The number of applications for this circuit is enormous, ranging from a level control for hydro cultures to the kitchen-is-under-water-because-of-the-washing-machine-detector. It

must be pointed out that the title is not quite correct as the LM 1830 from National Semiconductor will only detect conductive fluids, but, as most common liquids are conductive, this should not present a problem.

The frequency of the internal oscillator of the IC is 6 kHz (determined by capacitor C1). The oscillator output amplitude is approximately 2.4 V peak to peak and is fed to the probe via an internal resistor of 13 k and capacitor C2. When the probe is immersed in a conductive fluid the output of the oscillator is effectively 'shorted' to earth via the fluid. If the fluid level then falls below the end of the probe, the detector input (pin 10) will be provided with the 6 kHz output of the oscillator. Transistor T1 will conduct and switch on one of the three indicator systems.

An a.c. waveform was chosen for the probe for a very good reason. The major advantage of a.c. is the fact that the *average* current through the probe will be zero, thus preventing polarisation of the probe, as so often happens. The amplitude of this waveform is 2.4 V as previously mentioned, but between -1.2 V and $+1.2$ V. The internal transistor T1

conducts only on the positive edge of the probe signal waveform with the result that the loudspeaker (if used) will produce a 6 kHz tone. Increasing the value of C1 would lower the frequency. The LED also flashes at a frequency of 6 kHz but this is not visibly apparent. However, the relay would not take kindly to being switched on and off at this speed and therefore capacitor C3 must be included to smooth the way. Personal preference and the application will dictate which of the three indicator methods are used, I, II or III. Whatever choice is made it should be remembered that the current passing through the internal transistor T1 must not be allowed to exceed 20 mA. The values shown in the circuit diagram for the series resistors (270 Ω) have been chosen for the minimum supply voltage of 5 V. These values must be increased for higher supply voltage levels.

If a 40 Ω loudspeaker proves to be difficult to find it is possible to use one of a lower impedance. Unfortunately, this will mean a decrease in volume but that may be acceptable.

(National Semiconductor)

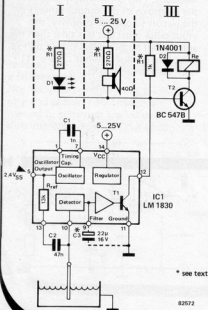

* see text

82572

68

voltage controlled waveform generator

an economical AF waveform source

The IC used in this circuit is well known to readers of Elektor. The circuit itself would have been familiar if it had not been for the control circuit around IC2 which replaces the usual potentiometer for frequency control. Readers may suspect that this has something to do with voltage control . . . and they would be right. Basically the frequency of this generator depends on the value of capacitor C3 and the current level at pin 7.

According to Ohm's law the cur-

rent is dependant on the resistance in the circuit and the voltage across it. The voltage at pin 7 is stabilised at 3 V inside the IC. The current level flowing through R5 (1 k Ω) will depend on the voltage level at the output of IC2. Obviously, if this is 3 V there will be no current through R5! The maximum

current of $\frac{3\text{ V}}{1\text{ k}} = 3\text{ mA}$ will occur

when the output of IC2 is 0 V. It can be seen then that frequency is directly proportional to the output voltage

level of IC2, the lower the voltage the higher the current and therefore the higher the frequency.

The output voltage of IC2 increases with U_{IN} and with a range of 0 . . . 3 V the highest frequency is achieved with U_{IN} at 3 V. If U_{IN} rises above this value (up to the maximum supply voltage), the frequency will remain the same. The IC will not be damaged providing U_{IN} does not become negative. The lowest possible frequency is determined by the lowest value of R6 which will

still allow a little current into pin 7 when U_{in} is at 0 V. The lowest output frequency can be set by means of P2. This can be carried out by measuring the voltage across R5 and adjusted to 0 V by turning P2. It should also be possible to set the lowest output frequency by ear. This will be approximately 80 kHz with the values shown in the circuit diagram. The highest frequency will be about 25 kHz and can be calculated as follows:

$$f = \frac{U_{in}}{3 \cdot R5 \cdot C3} + \frac{1}{R6 \cdot C3}$$

(Hz, V, Ω , F)

The frequency will be 8.5 kHz/V when $R5 = 1 \text{ k}$ and $C3 = 39 \text{ n}$. If $C3 = 100 \text{ n}$ the frequency range will be from 30 Hz to 10 kHz (3.3 kHz/V). A range of 10 Hz to 3 kHz can be achieved when $C3 = 330 \text{ n}$ (1 kHz/V). The generator IC itself, the 2206, is configured in the normal manner.

Switching between sine wave and triangular wave form outputs is carried out by switch P1. The output amplitude is set by P1, maximum 3 V_{pp} and 6 V_{pp} for sine and triangular wave respectively when $U_B = 12 \text{ V}$. Any d.c. content in the output will be filtered out with C6. The output impedance is approximately 600 Ω . The other output of the IC is a symmetrical square wave with an amplitude corresponding to the supply voltage.

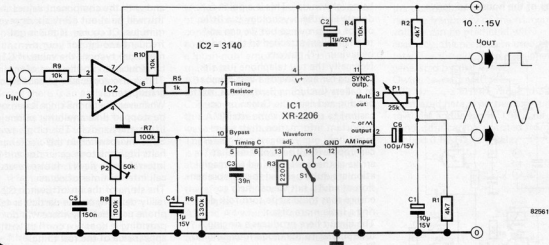

69 economical battery tester

battery condition in a flash

Battery testers are used to give a decisive answer concerning the condition of a battery. The voltage level is normally used as an indication of the battery when it is in operation. Obviously the test circuit most not form a considerable additional load during the measurement procedure.

This particular battery tester consumes a negligible amount of energy. A brief single flash of the LED indicates that the voltage level of the battery in the portable radio, cassette tape recorder and so on is still sufficient.

This flash is produced as a result of capacitor C1

discharging across LED D1, which is only possible when the battery supplies enough voltage. Depressing switch S1 will cause transistor T1 to conduct, so that C1 can discharge across the LED via the current-limiting resistor R3. The minimum battery voltage required is determined by the voltage divider R1/R2. The value for R2 and R3 must be calculated as follows:

$$R2 = \frac{0.6 \times R1}{U_{bmin} - 0.6} [\Omega]$$

$$R3 = \frac{U_b - 1.4}{0.2} [\Omega]$$

For instance, with a minimum battery voltage of 6.5 V (9 V battery), $R2 = 10 \text{ k}$ and $R3 = 39 \Omega$.

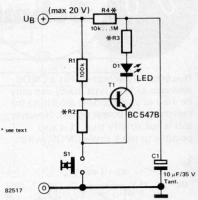

The value for R4 has to be between 10 k and 1 M. The tester becomes even more economical with higher values, but a check will take longer. The battery can be tested over a period of approximately 10 seconds when $R4 = 100 \text{ k}$.

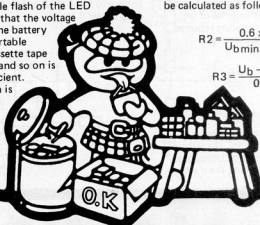

70

telephone bell

the phantom caller

To many adults it is surprising how much pleasure that the youngest members of the house can derive

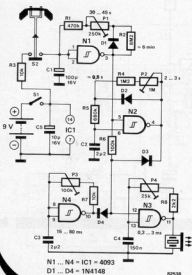

from a toy telephone. In their eyes the use of a telephone is akin to being 'grown-up'. This is a point for debate and the psychology is a little out of our province but we can add to the realism attached to this 'adult behaviour' (?) pattern.

Normally the toy telephone just sits, waiting for any one of a vast number of callers (including Santa Claus, the pet dog and even the Queen on occasion) to ring with some vitally important information that, seemingly, only our youngest and dearest can cope with. The problems that arrive at the local terminal to Imagination are quite beyond the comprehension of adults but we can help to ensure that these strife-torn folk do ring a little more often.

The circuit here produces a ringing tone similar to the modern telephone. This occurs every few minutes and stops when the handset is removed from the receiver cradle. Schmitt-trigger gates are used in the construction N1...N4. Gates N3 and N4 constitute the tone generator while N2

creates the ringing tone interval. The frequency of calls is left to gate N1 and with the component values shown this will be about every six or seven minutes. Of course, if this is not frequent enough for your own miniature tycoon, the value of C1 can be reduced to up the pace of business. This is also applicable to calls from grandparents.

Whenever the phone rings it can only be stopped (like any other phone) by lifting the handset. This closes switch S2 (a microswitch in the cradle) and halts both the tone generator and tone interval timer via N1. It also resets the call interval timer of course.

The siting of the on/off switch S2 really depends on the particular telephone used but anywhere will do providing it does not conflict with the appearance of the real thing.

One final word in the interests of the real world. Have you noticed that the children never seem to get a wrong number... a crossed line... and they can raise directory enquiries in pure seconds...!

71

CMOS switch Schmitt trigger

an unusual use for an electronic switch

It is generally accepted that a CMOS analogue switch (type 4066) can only be used as an electronic substitute for switching low power signals. However, this is not strictly true. It is also possible to use a single CMOS switch

as a Schmitt trigger. This can be very useful as, if a Schmitt trigger is required and not all of the CMOS switches available in a single IC have been used, the circuit in figure 1 can be used to avoid the expense of an extra IC. The resistor values required for the Schmitt trigger can be calculated as follows:

$$0 \text{ to } 1 \text{ transition} \\ \text{threshold} = U_b \cdot \left(1 + \frac{R_1}{R_2}\right)$$

$$1 \text{ to } 0 \text{ transition} \\ \text{threshold} = U_b \cdot \left(1 - \frac{R_1}{R_2}\right)$$

An interesting variation of the circuit is shown in figure 2. Here, the trigger section is combined with the voltage divider in such a way that the divider

becomes dependent on the trigger voltage level. Applications include limiting circuitry and auto-ranging. It is advisable to ensure that the input voltage to the CMOS switch does not drop below 3 V.

1

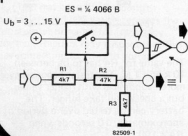

2

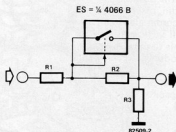

72

universal VCF

voltage controlled bandpass filter

The term voltage controlled filter (VCF) frequently crops up in connection with synthesizers. As its name suggests, a VCF is a filter that is controlled and adjusted by applying different voltages. This particular circuit consists of a voltage controlled audio bandpass filter with a variable IF and bandwidth. At the heart of the circuit there is an active bandpass filter around A2. 33 n capacitors are connected in parallel to the frequency-determining 1 n capacitors by way of ES3 and ES4. The electronic switches are controlled by means of a high frequency signal having a variable duty cycle. When an electronic switch and a capacitor are connected in series, they have the same average duty cycle as a variable capacitor. This enables the intermediate frequency (IF) range of the filter to be adjusted. Similarly, ES2 affects the gain of A2 and therefore the bandwidth, or rather the Q factor. Unfortunately, a reduction

in bandwidth in this type of filter automatically leads to a rise in gain (A2), which would restrict the number of possible applications for the filter considerably. ES1 together with A1 compensates for this by providing a 'push-pull' amplification control to the input.

A5 is connected as a standard (opamp) astable multivibrator. But beware! Contrary to what you might expect, this AMV does not produce a square wave but a triangular voltage.

The reason for this is simply that A5 is a 741 IC and much too slow to be able to produce a square wave signal at such high frequencies. Instead, it therefore produces a triangular signal. The signal is now applied to opamps A3 and A4 which act as comparators. They compare the triangular voltage to the signals fed and adjusted by the potentiometers. The result is a square wave voltage at the output with a constant frequency, but having a duty

cycle that can be adjusted by the voltage at the non-inverting inputs of the opamps. As neither the amplitude nor the frequency of the triangular voltage can be predicted with accuracy, the presets are used to interface the circuit to the signal generated by the 741 IC.

Owing to its presettable 100 Hz ... 3 kHz IF range, the VCF illustrated here is particularly suited to audio applications. The filter bandwidth can be adjusted from around 0.5 kHz to 3 kHz.

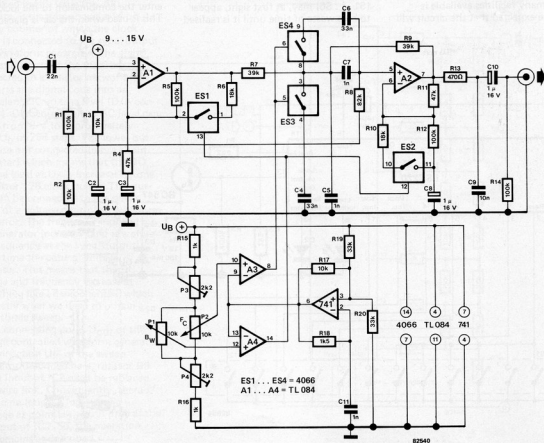

73

keyless lock

electronic theft protection

Out of the enormous variety of ICs produced today, the number that are designed for use in one specific application represents a relatively small percentage. The basis of the circuit here contains an IC that is from this category. It is the LSI 7220 from LSI Computer Systems and fulfills all the functions for an automatic keyless lock system. However, it is possible to use it for domestic purposes, an electronic safe lock, for instance. When fitted to a car, the ignition circuit is immobilised until the correct code combination is entered via a keyboard consisting of 10 or more keys. Other facilities are also available from the IC. A LED displays the condition of the lock (locked/unlocked). A very cunning feature is the fact that the lock combination is set by the constructor. It is also possible to allow another person to drive the car without disclosing the code or even the existence of the system. For so many facilities available it could be expected that the circuit will

be a rather fearsome affair and this would be true if it were not for the IC. While this could be said of virtually any IC, the specialised nature of the one we use here reduces the discrete components to almost nil. A glance at the circuit diagram shows that, besides the IC, only a handful of components are required. In fact, so little of an actual circuit exists that, having stated that a logic 1 from pin 13 of the IC will switch on the relay via T1, we have said it all! Not quite true of course, but the relay is the operative element — it switches the ignition system on.

What else are we left with? The object of the exercise is to enter a code into the system and this is carried out via four of the keys shown in the diagram, S7 . . . S10. These keys must be pressed in precisely that order to operate the relay. This obviously leaves a few more keys to be explained away. The six switches to the left (S1 . . . S6) may, at first sight, appear to be a waste of time until it is realised

that they are dummies. That is, we (and now you) know that if any of these switches are pressed, the lock will remain locked (reset), regardless the combination entered on the other keys (S7 . . . S10). The trick is to physically place all the switches in any order (not as shown here!) and number them in that order. This means that only you know the position of the dummies! For instance, S7 here (a code switch) could end up as number four (for argument's sake) and S1 (a reset switch) could end up as number 5 and so on. It should be noted at this point that as many reset (or dummy) keys as desired can be used.

There are still two switches left to deal with and the first of these, in logical sequence, is S12, termed the 'save' key. In short, depressing this key before the ignition is switched off, will allow the car to be started straight away next time without the need to enter the combination to the lock. This is used when the car is placed in a

* see text

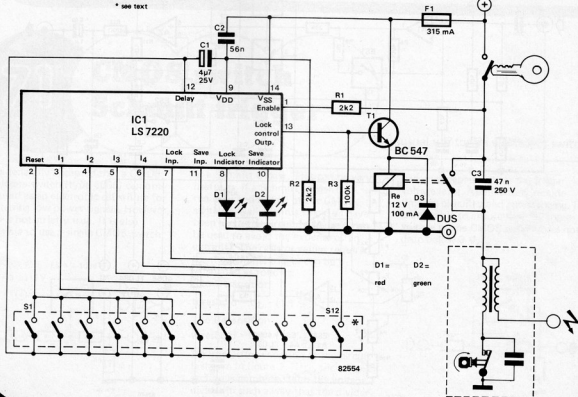

garage for servicing, for instance. This (effectively out of service) state of the lock will be indicated by LED D2 being lit. To return the lock to normal, brings us to the last switch, S11. This must be pressed just before turning the ignition off to return the lock to its normal operational status, as indicated by LED D1!

So, now what is left? Sharp-eyed readers will have noted that there is some sort of delay noted at pin 12 of the IC and this is easily explained.

Visualise the situation when the car engine stalls on a busy roundabout!

With the rest of the world encased in motor cars attempting to go round,

under or through our unfortunate reader, he is frantically trying to enter the correct combination into the keyboard! No it does not happen this way, because C1 provides enough time (about 10 seconds) for the ignition to be switched off and on again without the need to enter the code.

Only one further point of note: The 'enable' input to the IC (pin 1) is taken directly from the ignition switch as shown. The capacitor C3 is used to disable the ignition circuit and is about as good a method as any. It is best fitted (and disguised) as close as possible to the distributor.

The usual points apply about hiding

or disguising the protection wiring and (perhaps most important) the relay.

The latter should be of the best quality and may be fitted together with the circuit inside a diecast aluminium box mounted directly onto the bulkhead. If the wiring is then fed through the back of the box, straight through the bulkhead, it will be even more difficult to trace, especially if all the visible wiring looks similar to the existing wiring in the car.

74

digital logarithmic sweep generator

for VCOs

J. Meijer

This circuit produces a logarithmic sweep output by digital means and has been designed for use with the voltage controlled waveform generator described in this issue (no. 68).

The circuit diagram shows a 14-bit binary counter of which the clock input is connected to the sync. output of a waveform generator. The eight highest outputs of the 4020 are connected to a resistor network that converts the digital code into an equivalent DC voltage level (D/A converter). Consequently the DC level can range from 0 V to approximately $1/5 \cdot U_B$ in 256 steps. The lower outputs are not connected (more about this later) which means that the DC voltage level at U_{OUT} increases by one step after 128 clock pulses. This output can be connected to the sweep input of a voltage controlled waveform generator. The frequency supplied by the generator increases (and therefore the frequency at the sync. output) every time the control voltage increases. This means that the DC voltage and frequency increase at something like an exponential, which is exactly what we need to obtain a logarithmic sweep.

When connecting point U_{OUT} of the voltage controlled waveform generator to connection U_{IN} of the sweep generator described here, resistor R9 at the input of IC2 must be replaced by a wire link. Consequently, there will be no longer a logarithmic voltage at point U_{OUT} , but only at the output of IC2. So, the operation remains as described.

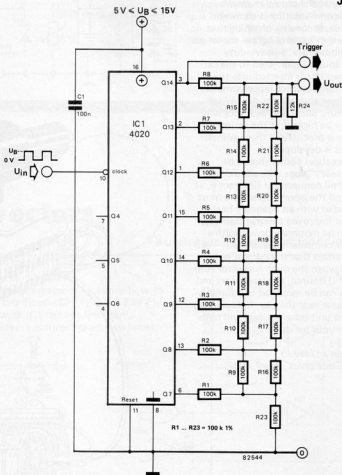

The combination sweep circuit and voltage controlled waveform generator must be fed by 12 V and can be calibrated in the following manner. Temporarily connect the reset pin of the 4020 to the supply voltage (+12 V). Then set the frequency at pin 11 of the XR 2206 to 80 Hz. Now connect the reset pin back to 0 V. On

initial switch-on, the sweep frequency (the clock frequency of IC1) will begin at the lowest point (80 Hz) and remains there for almost one second. After this time-period the frequency will increase by one step and so on. The process continues until 20 kHz is reached. The sweep speed can be doubled by

connecting resistors R1 . . . R8 in the sweep circuit to the Q6 . . . Q13 instead of the Q7 . . . Q14 outputs. Connecting these resistors to Q5 . . . Q12 increases this frequency by a factor two again and finally the initial clock speed can even be multiplied by eight by connecting them to the Q4 . . . Q11 outputs.

75

car lock defroster

open that door!

You're cold and in a hurry, and your car door won't unlock . . . a well-known hazard to drivers in winter! 'Forewarned is forearmed', of course, and you may have one of those handy little de-icing sprays. In our experience, however, they conform strictly to Murphy's Law and tend to be empty at the crucial moment.

An electronic solution is shown here. In essence, it consists of a plug that fits into the cigarette lighter socket on the dashboard and a heavy-duty current source, connected to the car key. When this is inserted into the lock, a heavy current (approximately 10 A) flows through the entire lock mechanism. Since the resistance will normally be highest at the various joints, it is precisely at these points that heat is developed!

A few practical points should be noted. Heavy-gauge wire should be used for all connections (2.5 mm ϕ , at least), and the power transistors must be provided with an adequate heat-sink. For improved thermal stability, they can be mounted close together (using mica insulating washers!) — this has the effect that the current is reduced when the main transistor runs too hot. If desired, the transistors and resistors can be mounted in a suitably-shaped case near the key; holding this, while the unit is being used, will help to warm your hands!

(Based on an idea in 'Radio Electronics', April 1982)

1

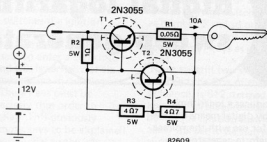

2

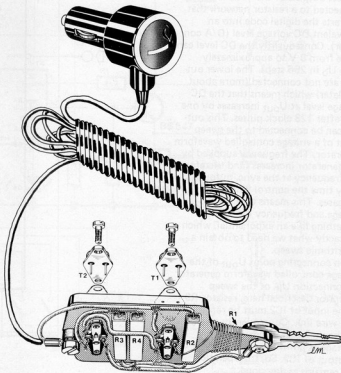

76

LED tuning indicator

illuminated tuning aid

This LED field strength meter can be connected to FM receivers in which the CA3189E IC is used in the IF stage. An example is the FM, IF stage described in the July/August 1979 issue of Elektor. A bar display is constructed with a UAA180 and 12 LEDs.

Preset P1 sets the sensitivity of the circuit. The voltage across P1 is stabilised to 5-6 V by R1 and D13. The input to the UAA180 is connected to pin 13 of the CA3189E. The relationship between the operational and the input voltage is clearly shown

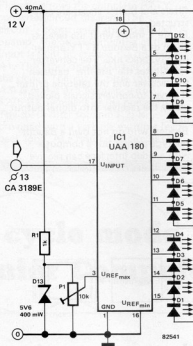
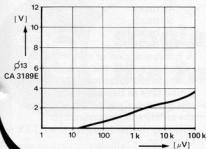

in the form of a graph with the vertical axis graduated in volts and the horizontal in micro-volts. A logarithmic progression is clearly illustrated. P1 is adjusted so that at the strongest transmitted signal all the LEDs are just lighting.

The circuit can also be used with other IF stages, but, then there may be a problem in calibration. Luckily most commercially made FM receivers already have a strength indication of some kind, which will show not only where to connect the input, but, will give some calibration parameters. The consumption of the circuit is rather low, being approximately 40 mA. If desired diodes D1 and D2 can be removed and substituted by wire links. The reason for doing this is because the first two LEDs will always flicker as a result of the ever present IF noise of the IF stage, and so eliminating them will allow the use of the available 10 LED arrays.

77

calling junior vectors

a useful junior computer modification

Appendix 3 of the Junior Computer Book 3 shows that the system vector data can be called from the standard EPROM with a busboard memory without having to use an extra EPROM. This circuit is an elegant alternative for solution number one. The following modifications must be incorporated. N102 must be replaced by a wire link. Wire links R-S and D-EX have to be mounted on the interface and standard board respectively. Pin 8, which is the output N34 of IC13 on the interface board, has to be bent out, so that the connection to point EX -8k0 is interrupted. This connection is now made via the open collector outputs

of gates N1 and N2. Only eight memory locations have to be 'sacrificed' (\$FFF8 . . . \$FFFF), because IC1 has not less than 13 inputs (connected address lines).



N1, N2 = 1/3 IC2 = 7417
N3 = IC1 = 74LS133

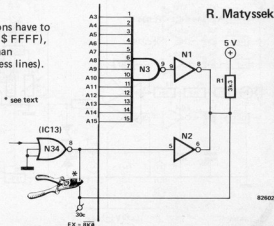

R. Matussek

82602

78

RTTY converter

radio teletype — a fascinating hobby for short wave listeners who own a computer

RTTY stands for radio teletype, during which data is transferred in various codes, one of the most important being the Baudot code. For the reception of teletype messages transmitted in the Baudot format a RTTY converter is needed, such as the one described here. The RTTY converter only contains a single IC, the TL 084, and a few external components. The IC incorporates a set of four opamps, around which the

filters and limiter stages are constructed.

Figure 1 shows what the receiver chain of a Baudot RTTY printer usually looks like. The converter constitutes the 'life-line' between the receiver and the teletype printer. It serves to convert signals picked up by the receiver into digital output data.

Readers who do not own a Baudot teletype printer but a computer with a video interface can receive and convert RTTY signals in the

manner shown in figure 2. In addition to the RTTY converter, a Baudot ASCII converter (in the form of the Junior Computer, for instance) and a video terminal (such as the Elekterminal) is required. In other words, a computer can take over the 5 bit Baudot to 7 bit ASCII conversion, with one proviso — the incoming program must be adapted to serial signals. The program must ensure that serial signals consisting of:

5 data bits
1 start bit
1 stop bit

are received at a transfer rate of:

45 bauds
50 bauds
75 bauds

or 110 bauds.

A full description of the software required to make the Junior Computer function as a Baudot ASCII converter would take us beyond the scope of this Summer Circuits' issue. Instead, the article will be confined to detailing the hardware for the RTTY converter.

The block diagram in figure 3 shows how the RTTY converter works. The converter input is connected in parallel to the loudspeaker (or headphones) of the short wave receiver. The two tone frequencies for mark and space (pulse and pulse interval) are sent to a limiter amplifier that limits the speaker signal to + or -5 V. The mark and space filters following the amplifier, filter the relevant frequencies out of the limited signal mixture and rectify them. The rectified signals reach an

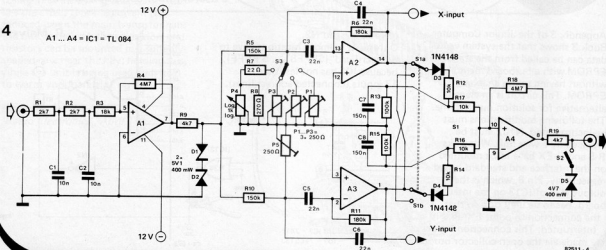
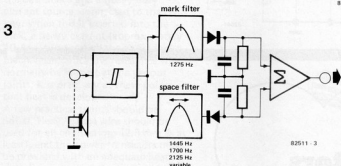
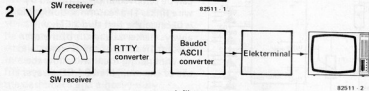
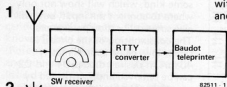

adder which also operates as a limiter. The decoded RTTY signal is then available at the output of the adder which can directly drive a Baudot teletype printer.

The mark filter has a fixed IF of 1275 Hz. In the space filter the IF may be converted from 1445 Hz to 2125 Hz via 1700 Hz. As a result, the

5

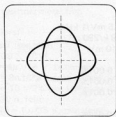

82511 5

frequency shift between the mark and space filters is 170 Hz, 425 Hz and 850 Hz, respectively, depending on the selected IF frequency. An additional range has now been provided within which the frequency may be varied continuously between 170 Hz and 1000 Hz. For the majority of RTTY transmitters to be received well, a frequency shift of 425 Hz is normally required.

Figure 4 shows the complete RTTY converter circuit diagram. The circuit is constructed around a quad opamp. The limiter amplifier at the input is built up around the opamp A1. The zener diodes D1 and D2 limit the signal. The 'mark' filter (opamp A3) is preset to a frequency of 1275 Hz by means of the preset P5. The space filter (opamp A2) is provided with a variable multiple feedback loop. As a result, the circuit can

switch to different IF frequencies, calibrated to 1445 Hz, 1700 Hz and 2125 Hz by presets P1...P3, respectively. Preset P4 adjusts the frequency shift in the 170 Hz...1000 Hz range.

The outputs of the two filters can drive the X-Y inputs of an oscilloscope directly. The converter is set at an optimum reception when a lissajous figure as shown in figure 5 appears on the oscilloscope screen. After being filtered, the signals have to be rectified and diodes D3 and D4 take care of this. They are followed by the low-pass filters R12/C7 and R14/C8 which smooth the signal. Opamp A4 adds the rectified signals. Switch S1 enables the mark/space signal to be inverted, if the computer interface hooked up to it requires negative logic. If switch S2 is closed, the zener diode D5 will limit the output signal to a TTL level.

79

single cycle mode for the Junior Computer

with logic level analyser

By connecting this auxiliary circuit, the Junior Computer can be run in single cycle mode. As opposed to single step operation, where a whole instruction is executed at a time, only a single clock cycle is processed in the single cycle mode. By combining the circuit with the logic analyser shown here, it is very easy to check the logic levels on the bus. The single cycle extension and the bus analyser help the operator trace hardware and software errors. The logic analyser is particularly handy for troubleshooting while the computer is 'running'.

After a reset signal the CPU is in a defined condition. Depressing S1 causes single clocks to be generated, in which case the CPU will start to execute the reset cycle (8 clocks). After this, the two reset vectors, RESL (EFFC) and RESH (FFFD) will be applied to the address bus and it is at these addresses that the program starts. The 'MCS 6500 Microcomputer Family Hardware Manual' (MOS Technology) contains further details about the execution of single instructions. Rockwell has also published a similar hardware book. It is important to make sure that the CPU does not stop when a write error occurs.

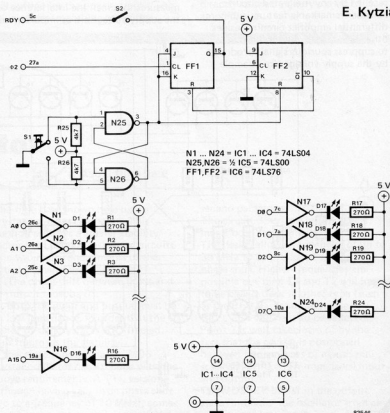

E. Kytzia

80

super low noise preamp

for magnetic cartridges

Preamplifiers for magnetic cartridges suffer from one major problem: Their own noise. This additional noise is produced mainly by the irregular current flow in the PN junction of the input transistor. The cause of this 'irregularity' is due to manufacturing tolerances. Some manufacturers, especially Japanese have designed extremely low noise transistors, but unfortunately these components are very hard to find and rather expensive.

For these reasons this circuit uses the physical law that voltages of non-correlating noise sources that are connected in parallel add geometrically, thus reducing the over-all noise of the parallel circuit. This magnetic preamp contains 8 transistors that are connected in parallel thus lowering the noise by factor $\sqrt{8}$, which is 2.82 or 9 dB.

The completely symmetrical circuit and the class A mode output transistor stage, formed by T17 and T18, allows low distortion factors that cannot be reached by any integrated circuit. Another remarkable feature is the differential amplifier circuit. Besides other advantages, this circuit is able to suppress spurious signals produced by the supply voltage (for example

Technical data

input sensitivity (200 mV output):	2.5 mV/1 kHz
input impedance	49 k/280 pF
maximum input voltage (at 1 kHz):	110 mV
distortion factors (200 mV output):	
100 Hz:	< 0.001%
1 kHz:	< 0.001%
20 kHz:	< 0.001%
overload distortion factors at +32 dB (8.4 V output):	
100 Hz:	< 0.016%
1 kHz:	< 0.01%
20 kHz:	< 0.01%
deviation from the RIAA characteristic:	
C4 ... C7 with 5% tolerance:	< ± 0.55 dB
with 2% tolerance:	< ± 0.25 dB
frequency response (C4 ... C7 at 5% tolerance):	
0 Hz ... 40 kHz and ± 0.55 dB	
> 86 dB	
signal-to-noise ratio	

hum and noise) by at least 50 dB. Together with the transistors T19 and T20 (connected as gyrators) and voltage regulators IC1 and IC2 a noise suppression of more than 150 dB is obtained. This is essential since the measures to screen the interference on the supply voltage are as important as

the constructional tricks to reduce the inherent noise of the amplifier stage, in order to obtain a high signal-to-noise ratio.

The preamp does *not* contain a coupling capacitor at its input, as this

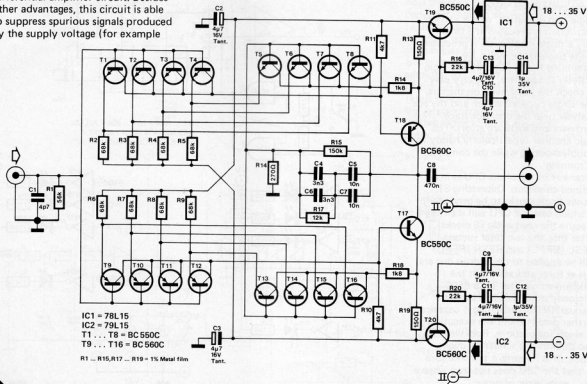

Parts list

Resistors:

- R1 = 56 k/1%
- R2 ... R9 = 68 k/1%
- R10, R11 = 4k7/1%
- R12, R18 = 1k8/1%
- R13, R19 = 150 Ω/1%
- R14 = 270 Ω/1%
- R15 = 150 k/1%
- R16, R20 = 22 k/1%
- R17 = 12 k/1%

All 1% resistors metal film

Capacitors:

- C1 = 4p7 (see text)
- C2, C3, C9 ... C11, C13 = 4μ7/16 V, tantalum
- C4, C6 = 3n3/2% (see technical data)
- C5, C7 = 10 n/2% (see technical data)
- C8 = 470 n, folio
- C12, C14 = 1 μ/35 V, tantalum

Semiconductors:

- T1 ... T8, T17, T19 = BC 550C, BC 414C
- T9 ... T16, T18, T20 = BC 560C, BC 416C
- IC1 = 78L15
- IC2 = 79L15

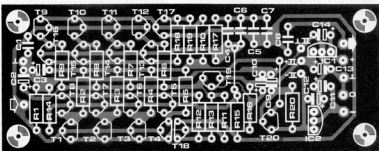
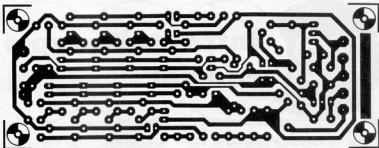

would produce additional noise. Therefore the transmission range already starts at the DC voltage level.

At first sight the constructor might be worried about the large number of resistors, but you will soon find out that it is not difficult to mount all components on the printed circuit board. This design does not suffer from oscillation tendencies or other 'semi-professional hobby amateur'

problems. The price for the components is quite reasonable. The voltage regulator ICs are only required once and the components C11 ... C14 and IC1, IC2 can be omitted when constructing a second (stereo) channel. The connections II⊖, II⊕ and II⊖ on both boards must be connected together. A small 2 x 15 V ... 24 V/50 mA transformer will suffice for the power supply. The value of the smoothing capacitors

must at least be 470 μF. The input impedance of the preamp can be adjusted to any cartridge by simply changing the values of R1 and C1. The amplification factor is determined by R14. When using a 100 Ω resistor for R1 and a 27 Ω resistor for R14, the preamp will be suitable for moving coil cartridges. In contrast to other preamps, the output connects directly to the auxiliary socket of the amplifier.

81

crystal oscillator

a stable time base

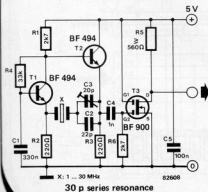

The time base shown here uses a crystal for series resonance. This method achieves a greater stability factor than parallel resonance circuits. The two main requirements of the active elements are:

1. The phase-shift between input and output must be 0°.
2. Both the input and output must be low impedance, in order that the Q factor of the crystal is not affected. This improves the stability.

It therefore follows that a CMOS crystal oscillator cannot cope with the above requirements. A TTL version, although having very little phase shift (up to a frequency of 10 MHz), comes no where near to complying with the

second parameter. The circuit described in this article meets both requirements. The design allows frequencies of up to 30 MHz to be produced without any phase shift. Higher frequencies are possible but then T1 and T2 will have to be changed for another type (such as the BFR 91), and the values of R1 ... R4 will have to be reduced. Point 2 is well taken care of by the fact that the crystal is positioned between two emitters of a push pull stage achieving a low impedance input and output. The MOSFET buffer in the output stage 'insulates' the oscillator from any circuit connected to it.

82

infra-red remote control

receiver

After the transmitter using the SL 490, published elsewhere in this issue, we come to the receiver, once again using Plessey ICs, SL 480 and ML 920.

Pulse pause modulation (PPM) is used with or without carrier, and automatic error detection is also incorporated. Although initially designed for TV remote control, the ICs can also be used for controlling 'HI-FI' equipment, lighting, toys and models.

Figure 1 shows the circuit diagram of the pulse amplifier. This mainly consists of three gain stages, each being decoupled by capacitors, so as to achieve low frequency roll-off, therefore eliminating AF noise. The transistor capacitor network around T1 actively simulates induction, preventing the diode D1 from saturating. In other words, it gets over the problem of high ambient light, such as sunlight, from saturating the receiver diode.

The photo diode D1 (which is buffered), sends negative going pulses to the input of the IC. This input is then amplified by the three stages, finally being inverted to give positive going PPM, compatible with the MOS decoder inputs.

Figure 2 shows the circuit diagram of the actual receiver, using the ML 920. The ML 920 demodulates the PPM signal, but not into simple on/off commands! 3 outputs are available which can be split up into three groups. 3 analogue (A1 . . . A3),

5 digital (D1 . . . D5) and 5 channels (C1 . . . C5), which although specifically for TV control can still be thought of as digital outputs.

These five outputs allow the switching of up to 20 TV channels. The information is present at the 5 outputs in binary coded form; EDCBA = 00000 . . . 10011. This information remains the same until a pulse re-addresses them. Whenever a switch-over is required (from one channel to another), this switching operation is simultaneously followed by a pulse released from D4. The receiver automatically ignores any attempt at switching to a channel above 20, and also ignores any instruction transmitted when more than one key (on the transmitter) is depressed at the same time. Should the channel information be required as separate outputs (instead of in binary), then the CMOS IC 4514 can be used to decode the information from binary. In this case the constructor must bear in mind that the ML 920 operates with negative logic. A logic 0 is interpreted as the operational voltage, a logic 1 as 0 V.

The analogue outputs of IC2 are used to control colour, volume and brightness. From now on it is probably better to itemise the pin functions of the IC but that would take up most of the issue, so it may be better to refer readers who are really interested in building a TV remote control to the

1

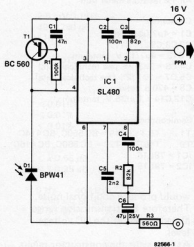

PLESSEY consumer application notes available on the ML 920.

Apart from the analogue outputs just described, the IC has outputs for: on/off, recall display, AFC, mute, colour/kill oscillator monitor, standby, step, and so on. Quite an extensive array of control facilities!

Remote control data PLESSEY SEMICONDUCTORS ML 920.

2

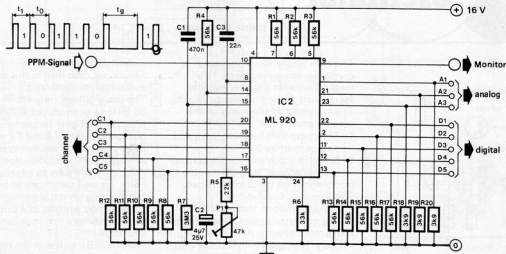

83

voltage controlled TTL oscillator

simple construction
using common ICs

The problem of not having the right IC to hand is a well known stumbling-block for constructors: When a VCO is required urgently, the ideal IC is invariably not available and those that are will probably not suit the purpose. It is therefore very handy to be able to have something 'home-made' for emergencies. This circuit will make sure that your hair will turn grey because of age and not because of this particular problem.

Whenever an oscillator with an adjustable frequency is required, it is desirable to use one that is voltage controlled, because this is as versatile as it is possible to get. Whereas a potentiometer is fine for manual setting, a control voltage is far more useful for automatic frequency control purposes. The circuit must have a wide frequency and supply range in order for it to be suitable for the majority of applications. This particular circuit has a frequency range of more than 1 : 1000 and can be used from AF up to 50 MHz.

The basis of the circuit is the well-known TTL Schmitt-trigger oscillator. The emitter follower T1, connected in front of N1, increases the input resistance and allows high values for the feedback resistor R1. The following section around T2 is the frequency control stage, which is

connected in parallel to R1. Diode D1 ensures that the capacitor charges very quickly. However, its discharge via T2 is controlled by the input voltage U_i . Therefore the output of the gate consists of a train of 'needle' pulses with a variable frequency. Strictly speaking R1 is superfluous, but it guarantees that the oscillator will start to operate, even in the absence of an input voltage.

The pulse duration mainly depends on the propagation delay of the Schmitt-trigger used (N1). Standard and LS TTL need about 30 ns and S TTL about 15 ns. A divide-by-two circuit (N2 and N3) follows the actual oscillator. This supplies a square wave output signal of half the oscillator frequency. The top end frequency limit is 15 and 30 MHz for the LS and S-type respectively.

With the very small coupling capacitors in mind, care must be taken with wiring. Further, a ceramic capacitor of 10...1000 nF must be fitted between pins 7 and 14 of the TTL IC. Resistors R2 and R3 must be used with standard and LS TTL, in order to prevent the divider from oscillating.

Negative feedback via C3 and D2 is provided to linearise the non-linear control stage of T2. A frequency proportional, negative voltage level is

2

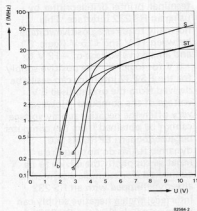

N. Rohde

provided across C2. Resistor R4 determines the level and was calculated in this circuit for a control voltage range of 0...10 V. The higher the control voltage, the bigger R4 can be, the better the linearity. Figure 2 shows the control characteristic of the oscillator with standard LS TTL (curves ST) and with Schottky TTL (curves S). The negative feedback can be switched off by means of S1. The curves indicated with 'b' are produced when using the negative feedback switch in position 'b'.

1

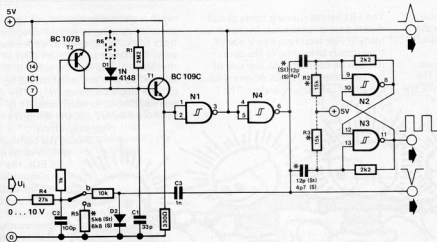

N1...N4 = IC1* = 74132, 74LS132, 74S132
D2 = DUG (AA118)

* 500 10X1

82584-1

84

RS 232
interface

RS 232 interface without a negative supply voltage

A microcomputer is usually connected to a peripheral device, such as terminal, printer or teleprinter by using an RS 232 interface. This normally requires a positive voltage between +5 V and +15 V (logic '0') and a negative voltage of -12 V to -5 V for logic '1'. The positive supply for the RS 232 interface can easily be derived from the unstabilised 5 V voltage of the computer. However, very often the negative supply voltage cannot be obtained from the computer because modern EPROMs and dynamic RAMs do not require a negative supply. If the device to be connected (for example a printer) is already equipped with an RS 232 interface, then a negative supply can be found at pin 3 of the RS 232 connector in the standby mode. Capacitor C1 charges via diode D1 and supplies the transmitter (T1) with a negative voltage.

T2 converts the negative level of the RS 232 transmission into a

positive 5 V level for the computer again.

Obviously, the circuit will not work when it is used at both ends of the RS 232 connection (i.e. both at transmitter and receiver).

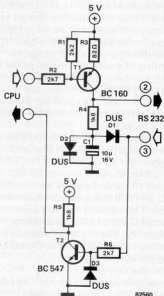

82560

85

magic
running lights

... full of surprises!

Elektor has lost track of the number of running light circuits that have seen the light on its pages in recent years. There must have been at least a hundred — which goes to show how versatile such designs are. In fact, the possibilities are endless and so are the patterns. It all depends on the imagination of the constructor.

The 10 channel running lights circuit shown here is remarkable in that it has many preset facilities. Every one of the outputs belonging to the counter IC1 can be connected to any one of the ten different output drivers with the aid of ten 10-way wafers. The

result is an immense variety of light patterns, running in various directions; from left to right, towards each other, away from each other, in all sorts of rhythms... The running speed is selected by S11 and is controlled by either a single oscillator (N1) or by two oscillators, in which case N1 is controlled by N2 and the result is a 'hopping' effect.

Should the constructor only wish to drive LEDs, the cathodes of LEDs D1... D10 may be grounded. The circuit diagram does, however,

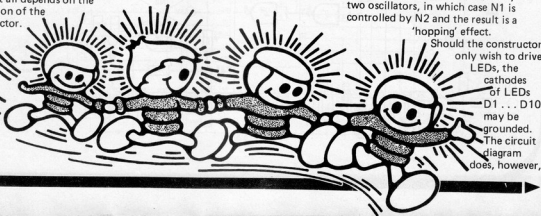

make provision for another alternative: the use of optocouplers to drive standard coloured light bulbs. A design on these lines, the "big VU meter", was published in the January 1981 issue. Whichever circuit you choose, it won't be a 'flash in the pan'!

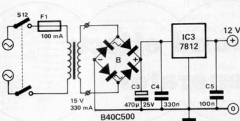

82518

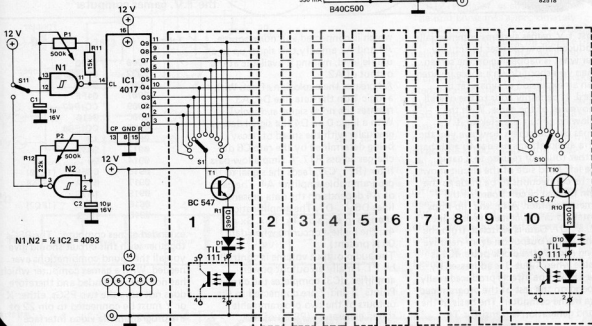

N1, N2 = 1/2 IC2 = 4093

86

stable start stop oscillator

for video character generators

Start/stop oscillators are indispensable in video interface circuits. Such oscillators have to be synchronised with differentiated character clock pulses and produce 7...12 pulses between character clocks. There are two aspects which are important to note here:

- The oscillator must start producing pulses after a delay of about 15 ns. This prevents the first pulse (the output signal) from coinciding with the positive-going edge of the trigger signal.
- The oscillator must stop as soon as the control signal goes low again.

The oscillator shown in the circuit diagram meets both of the above requirements. It starts after a slight delay whenever the input signal goes high and stops immediately the input signal reverts to logic zero.

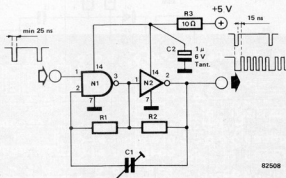

82508

R1, R2 = 560 Ω ... 4k7
C1 = 20 ... 80 p

N1 = 1/2 74LS00
N2 = 1/2 74LS04

87

sound effects generator

sound effects for
the T.V. games computer

Most T.V. games systems commercially produced allow the user to actually hear what is happening on the screen. When you shoot down a space invader, then an explosion or whatever is heard. It certainly adds to the overall enjoyment of the game. With the following circuit the Elektor T.V. games computer can now give you the extra audio effects needed to add that further touch of realism to a game. The left-hand side of the circuit shows all the connections to be made to the main printed circuit board of the games computer. After the flip-flops contained in IC1 come the data-lines D2 . . . D7. Data is switched from the input to the output on every negative going edge of the clock pulse. IC1 is enable when input B is addressed by line 1E80. The effects produced really depend on the rest of the programmed data in the computer. The basis of the sound generation is transistor T4,

which is connected as a noise source. A1 and A2 amplify this signal up to a usable level, making it available at the output of A2.

A3 creates the explosion effect. With a logic 1 on the data line D4, A3 releases the noise signal suddenly! With a logic 0 on D4 the signal decays gradually with the speed of decay being determined by the rate C6 discharges across R17. A simple low-pass filter (R21, C7), feeds the signal to the programmable amplifier A4. The gain of A4 depends on the data present on lines D6 . . . D7. The amplification changes in steps of, 1x, 1½x, 3x and 4x, the highest occurring when data 00 is present.

The audio output volume is controlled by P1. Finally an output power amplifier (IC3) completes the circuit. Points X and Y are connected to the outputs of the two programmable sound generators (PSGs) of the

Table 1

0900	7620
0902	0C1E89
0905	9A7B
0907	04FF
0909	CC1FC7
090C	0410
090E	CC1E80
0911	12
0912	9A7D
0914	20
0915	C8F8 (1E80)
0917	09EA (1E89)
0919	1A7C
091B	C8ED (1FC7)
091D	1B63

extended games computer. The PSGs together with this circuit should give you all the sound combinations ever needed. With a games computer which has not been extended and therefore does not have the two PSGs, either X or Y must be connected to pin 22 of the programmable video interface

1

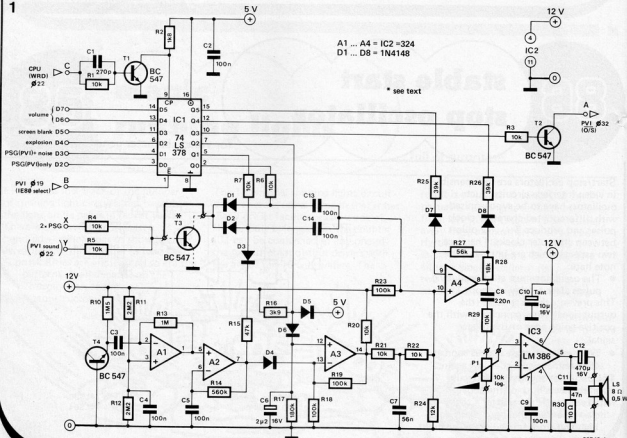

2a

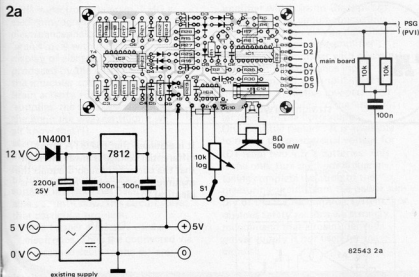

(PVI). Transistor T3, on the main board of the games computer is then not required.

The sound generator requires a voltage of 12 V. The computer itself cannot supply this. However, if the main computer power supply transformer has a 12 V tap, then a simple supply can be constructed using a diode and a 7812 regulator, as shown in figure 2. The unit consumes approximately 15 mA from the +5 V supply, whereas the +12 V supply must be capable of delivering about 150 mA, with the volume control fully up.

A change-over switch can be incorporated, to allow the effects to be bypassed if required. In this case each PSG output is connected to a 10 k resistor. The two resistors are interconnected and fed to one side of the switch via a 100 nF capacitor. The details are shown in figure 2a.

Figure 2b shows the function of the different 'bits'. The table illustrates a demonstration program. Depressing 'WCAS' will produce the explosion effect. When the sound generator is switched off, depressing the same code will result in a loud hum being heard!

2b

	7	6	5	4	3	2	1	0
IE80	level	level	screen blank	noise	PSG + noise	PSG (PVI)	—	—

82543-2b

Parts list

Resistors:

R1, R3 . . . R7, R20,
R21, R22, R29 = 10 k
R2 = 1 k8
R10 = 1 M5
R11, R12 = 2 M2
R13 = 1 M
R14 = 560 k
R15 = 47 k
R16 = 3k9
R17 = 180 k
R18, R19, R23 = 100 k
R24 = 12 k
R25, R26 = 39 k
R27 = 56 k
R28 = 18 k
R30 = 10 Ω
P1 = 10 k log potentiometer

Capacitors:

C1 = 270 p
C2 . . . C5, C9, C13, C14 = 100 n
C6 = 2µ2/16 V
C7 = 56 n
C8 = 220 n
C10 = 10 µ/16 V
C11 = 47 n
C12 = 470 µ/16 V

Semiconductors:

D1 . . . D8 = 1N4148
T1, T2, T4 = BC 547
T3 = BC 547 (part of games computer)
IC1 = 74LS378
IC2 = 324
IC3 = LM 386

Miscellaneous:

LS = 8 Ω, 0,5 W loudspeaker

3

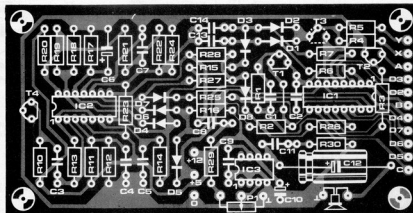
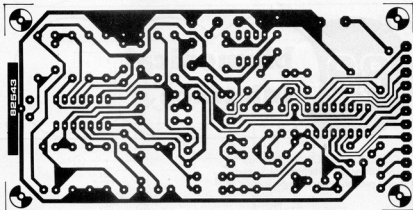

88

VCOTA

straightforward VCO with 13600

This application of the 'miracle chip' LM/XR 13600 deals with a voltage controlled triangular oscillator. The OTA is fed back from the output to the input via the voltage divider consisting of R1 and R2. This feedback from the output to the input is performed via capacitor C, which has a linear charge and discharge rate. The current through C also flows through one of the two diodes; therefore the trigger points are at ± 0.6 V. The frequency can be calculated as follows:

$$f \approx \frac{U_c + 15}{2.4C \cdot R_c} \quad [\text{Hz, V, F}]$$

The output voltage is:

$$1.2 \cdot \frac{R_1 + R_2}{R_2} V_{pp}$$

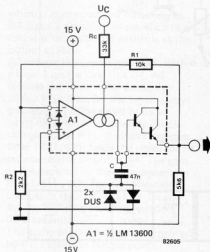

It is assumed that the OTA input differential voltage is always so high that the current through C equals the maximum I_{ABC} , which in its turn is identical to:

$$\frac{U_c + 15}{R_c}$$

National/Exar Application

89

biomedical interface

bio signals for the microcomputer

ECG, EMG and EEG are common expressions for 'bioelectronics', but it will probably be 'mumbo jumbo'

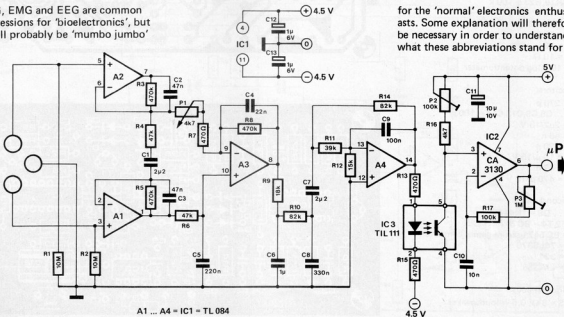

A1 ... A4 = IC1 = TL 084

for the 'normal' electronics enthusiasts. Some explanation will therefore be necessary in order to understand what these abbreviations stand for:

82671

ECG = electrocardiogram, EMG = electromyogram and EEG = electroencephalogram. All these 'grams' deal with measurement and display of electric voltages being produced by the heart beat (ECG), the muscular activity (EMG) and brain activity (EEG). The heart 'supplies' the strongest signals and the brain the weakest (didn't we all know that?)

Many microprocessor enthusiasts may have had some thoughts of performing physical tests by means of their computer. Unfortunately no suitable interface has been available... until now; this circuit solves that particular problem.

Three copper plates are used as electrodes. They are connected via screened cable to the differential

amplifier which forms the input of the circuit. The circuit consisting of A1...A3 can also be described as an 'instrumentation amplifier'; a differential amplifier with opamps and two high impedance inputs. The output signal of this input stage is filtered by the active low-pass filter A4 before being fed to the 'transmitter diode' in the optocoupler. One essential remark: It is advisable to derive the operational voltage for IC1 from two 4.5 V batteries. This is the only sure method of guaranteeing complete isolation of the measuring circuit from the power supply of the microcomputer system. For obvious safety reasons we strongly recommend that a mains derived power supply is *not* used for the circuit!

The 'receiver transistor' in the optocoupler conducts the signal to IC2, where it is converted into a pulse-width modulated signal. The duty cycle of the output signal (at the 'shorted' input of the differential amplifier) is set to 50% by means of P2. The frequency of the output signal can be selected with the aid of P3. Last, but not least, the amplification factor of the input signal can be set with P1.

Developing the software is up to the constructor. Those who are interested in bioelectronics and want to know something more about it can read the book mentioned at the end of this article.

Literature: Holz/kreysch, bioelectronics, Frankh, 1982.

90

dissipation limiter

energy saving circuit

Variable power supplies have to meet a lot of requirements which are very hard to realise from a technical point of view. The maximum output voltage must be as high as possible while the current capability needs to be at least one or two amps to be of some use. Constructors who have already tried to build their own power supply will know that the dissipation of the power transistors can become extremely high. One of our readers found a way to get around this problem for the majority of cases — and quite economically! Maximum dissipation occurs with high currents at low output voltage levels. For this reason switched primary windings on the transformer are used in many cases, as an effective way to limit the losses. However, the circuit shown here might present a solution to many readers who do not want the added expense of a transformer of this type. It is possible to realise double the voltage and half the current with the aid of a single switch contact, which can be operated manually or automatically. The two electrolytic capacitors are the most expensive components in the circuit.

The existing power supply is inside the dotted lines shown of the circuit diagram. Either the normal full wave rectification or voltage doubling can be selected by means of switch contact

S1. In the first case S1 will be open. The transformer voltages shown in

the circuit diagram are intended as an example. The circuit will function just as well with other voltages of course, on the condition that the electrolytic capacitors and transistors are able to cope with these values. Automatic switching can be achieved by the circuitry constructed around T1, T2 and a relay. As soon as the output voltage of the stabilisation circuit exceeds 30 V (this value can be set by varying R3) T2 will conduct and the relay will drop out. S1, which is a normally open contact of the relay will now close, so that voltage doubling is achieved. The auxiliary circuitry with T1 and T2 can be fed from a separate supply, preferably with a voltage that has the

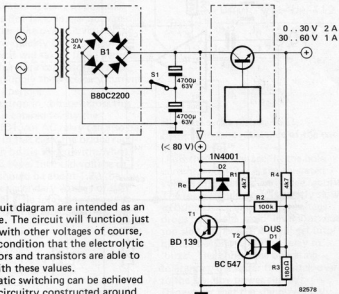

H. Burke

same value as that of the relay coil. However, it is also possible to derive this supply from the voltage across both smoothing capacitors. In this case particular attention has to be paid to the fact that T1 and the relay must be able to cope with the maximum voltage and T2 should be able to deal with at least half of this value.

91

stereo power amplifier

a complete stereo power amplifier on one chip

National Semiconductor's, LM 2896 contains not one, but, two high performance power amplifiers able to handle supply voltages up to 15 V. With a 12 V supply the IC can deliver 2.5 W per channel into 8 Ω . With the same supply and load, it is capable of delivering 9 W in 'bridge mode'. These are certainly good performance figures, especially when you consider the low number of external components needed.

Figure 1 shows the circuit diagram of the complete amplifier. As you will note, the components for each channel are identical.

Resistors R1 and R2 together with capacitor C2 form the negative feedback loop. The band-width of the amplifier is determined by R2 and C3. R3 and C4 ensure maximum gain,

specifications

supply voltage
quiescent current
output
distortion
(1 kHz, 12 V, R_L , 8 Ω)

Gain	180x	20 mV	360x
minimum input level		100 k Ω	
input impedance			
frequency response (-3 dB)	30 Hz ... 30 kHz	30 Hz ... 20 kHz	

with R4 and C6 stabilising the output. Capacitor C8 smoothes the supply, eliminating any possible 'spikes'. When operating in stereo mode, coupling capacitors (C5) are required at the output.

Figure 2 shows the track pattern and component overlay for a stereo version using a single IC. A 10 k log poten-

tiometer at the input is sufficient for controlling the output volume. When using the amplifier in 'bridge mode', certain changes have to be made. These are denoted by dotted lines on the track pattern and circuit diagram. Obviously in order to achieve high power in stereo, two complete circuits are required.

Figure 3 illustrates the output power to supply voltage characteristics of the amplifier, for different modes and loads. When operating in 'bridge mode', RB and CB must be added, and the coupling capacitors C5 removed,

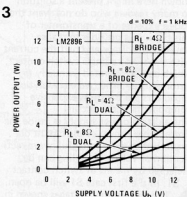
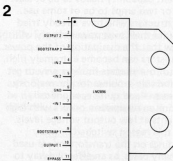
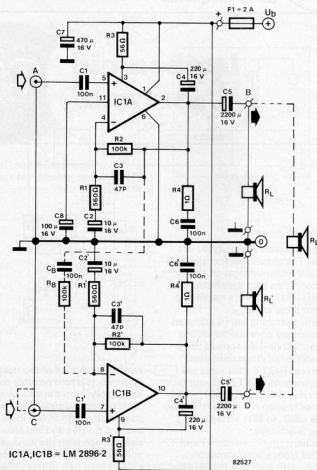

Parts list

Resistors:

- R1, R1' = 560 Ω
 R2, R2' = 100 k
 R3, R3' = 56 Ω
 R4, R4' = 1 Ω
 R_B = 100 k
 (for bridge mode only)

Capacitors:

- C1, C1', C6, C6' = 100 n
 C2, C2' = 10 μ/16 V
 C3, C3' = 47 p
 C4, C4' = 220 μ/16 V
 C5, C5' = 2200 μ/16 V
 (not needed for bridge mode)
 C7 = 470 μ/16 V
 C8 = 100 μ/16 V
 C_B = 100 n
 (for bridge mode only)

Semiconductors:

- IC1 = LM 2896-2

4

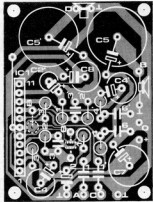

substituting wire links. Keep in mind that for high power applications the IC will require an adequate heat sink.

A simple power supply can be constructed using the 7812 voltage regulator. For full output power into 4 Ω, a 1 AMP supply is needed.

92

power failure protection

memory jogger

Nothing can be worse than having even a brief collapse of the mains supply voltage when working with a system using volatile memory, like RAM. After the interruption, no matter how small, it will be apparent that the data in the RAM has well and truly evaporated. For that reason a lot of circuits are designed to side step the problem of either long, or short term, mains supply failure. The circuit described here can be placed into the same general category. An additional bridge rectifier is added to the existing power supply, together with a relay Re1 in series with resistor R1. The contact for the standby power supply of 10-15 V is made by Re1. The circuit must detect a mains

voltage collapse as early as possible. As soon as Re1 is no longer activated, the batteries take over. Obviously, no matter how quickly this changeover takes place it will take a finite period of time, therefore capacitor C1 must be able to supply the necessary current during this period.

Any slight drop in voltage across this capacitor is catered for by the regulator IC1. An AC relay can also be used and, in this case, the bridge rectifier B2 can be dispensed with. When using a DC type, the hold voltage of the relay should be about 1.2 V below that of the secondary voltage of the transformer. The following formula should be used to establish the correct type.

$$R_1 = \frac{2 \cdot U_{RMS} \cdot \sqrt{2} - U_h - 1.2}{I_h} R_{Re1}$$

$$= \frac{0.9 \cdot U_{RMS} - 1.2 - 1}{U_h} R_{Re1}$$

$$I_h = \frac{U_h}{R_{Re1}}$$

R₁ = the series resistor in Ω, R_{Re1} being the resistance of the coil of the relay. U_h is the hold voltage, I_h the hold current, and 1.2 V is the tolerated voltage drop across the bridge rectifier. The relay should be sufficiently slow to bridge the gap when the voltage drops below the 'hold' level, but, not too slow, otherwise C1 will get into difficulties and cause the relay to 'buzz'. The tighter the operating tolerances, the faster the switch-over to the standby power supply. Remember that the standby supply does not necessarily have to power the complete system, but only the RAMs. In this way the accumulator will last that much longer.

It is possible to trickle charge the accumulator by connecting it via a series resistor from the voltage across C1 (in parallel with the relay contacts). The value of the resistor will depend on the specific accumulator (NiCad) in use.

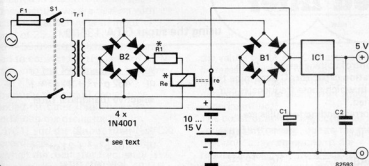

82593

93

12 dB VCF

voltage controlled Butterworth low-pass filter

Since their introduction in the early 70's OTAs have become a classical component for voltage controlled filters. This is especially true of the dual OTA XR 13600 because it already contains the necessary buffer stages. The dual version has an excellent synchronous operation and is ideal for second order filters. The circuit diagram here shows a low-pass filter of this type. A modulation range over several decades can be obtained, with a good linearity.

The 3 dB cutoff frequency of the filter depends on the transconductance (g_m) of the OTAs, and on the values of the resistors R and R_A and the capacitors C and $2 \cdot C$. The value of f_g can be calculated from the following:

$$f_g = \frac{R_A g_m}{(R + R_A) 2 \pi C}$$

R_C must be multiplied by two, as the The next question is: How do we know the g_m value? This is really quite simple; at room temperature the $g_m = 19.2 \cdot I_B$, where I_B is the current that flows into pins 1 and 16 of the IC (across R_C). The voltage at these pins is approximately 1.2 V more positive than the negative supply voltage (or -13.8 V with a ± 15 V supply voltage).

We can now extend the first formula as follows:

$$g_m = 19.2 \cdot \frac{U_C + 13.8 \text{ V}}{2 \cdot R_C}$$

current across R_C is divided between both OTAs.

The data with the values indicated in the circuit diagram are:

control characteristic; approximately 2 kHz per volt

f_g at $U_C = 0$ V, 28 kHz

f_g at $U_C = -13$ V, 1.5 kHz

f_g at $U_C = +6$ V, 40 kHz

Another value for the control characteristic and modulation range can be obtained quite easily by changing C and R_C .

National application

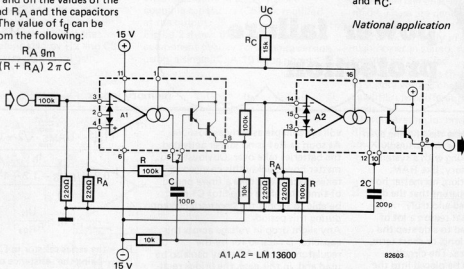

94

voltage controlled filter

using the super OTA 13600

The circuit diagram shown here is a National Semiconductor application of the LM/XR 13600, in this case used as a kind of state-variable filter. The circuit contains a selective filter output (u_1) and a low-pass filter (u_2). The centre frequency of the selective filter and the cutoff frequency of the low-pass filter can be influenced by

the control voltage level u_C . Both integration capacitors C determine the range in which these frequencies can be varied.

The corresponding formulas are:

$$p = j\omega; \quad \tau = \frac{C}{S}; \quad S = 19.2 \cdot I_{ABC};$$

$$I_{ABC} \approx \frac{u_C}{2 R_C}; \quad R_C = 15 \text{ k}\Omega$$

$$\frac{u_1}{u_i} = \frac{42 p\tau}{462 p^2 \tau^2 + 21 p\tau + 1}$$

selective (bandpass) filter

$$\frac{u_2}{u_i} = \frac{2}{462 p^2 \tau^2 + 21 p\tau + 1}$$

low-pass filter

Cutoff frequency and central frequency respectively are:

$$\approx \frac{1}{21 \tau}$$

Literature:

"When is an OTA not an OTA?", and "The 13600, a new OTA", both published in the April 1982 issue of Elektor.

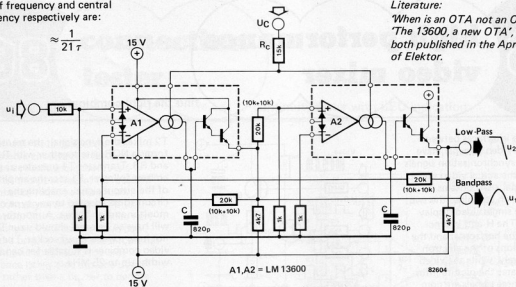

95

simple frequency converter

a TBA 120 application

During the last few years the TBA 120 has become one of the most frequently used ICs in RF techniques. Although originally meant as IF amplifier/FM demodulator, the TBA 120 can be used for a wide range of applications. This converter circuit is just one example.

The initial requirements for a converter are a mixing stage and an oscillator. The multiplier in the IC suits the needs of a mixing stage perfectly well. The oscillator can be realised by a selective (positive coupling) feedback of the amplifier section of the TBA 120 by means of the resonance circuit L1/C1. The oscillator will operate at a frequency of 46 MHz with the values indicated in the circuit diagram. Consequently, we are dealing with a circuit that converts an input signal of 35.3 MHz into 10.7 MHz ($46 - 35.3 = 10.7$ MHz). This can be used to convert the IF signal of a TV tuner into the intermediate frequency of an FM receiver.

Obviously the circuit can also be applied for other frequencies, by modifying the oscillator circuit (L1/C1) and the output filter (L2/C2) accordingly.

When the oscillator frequency is considerably lower than 46 MHz,

R. van den Brink

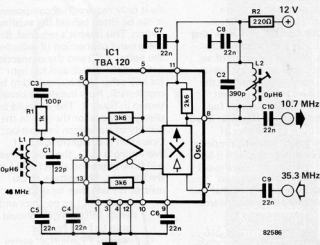

the values of R1 and C3 have to be increased slightly. However, their value is not very critical and can be determined quite easily after some experimenting.

The construction of the converter is very straightforward, due to the fact that only a few components are required. However, some attention has to be paid to the common basic rules

for RF circuits, such as:

- Try to retain as much 'ground plane' as possible, when etching the printed circuit board.
- Keep the tracking and wiring as short as possible.
- Use the shortest distance from the point to be decoupled to the ground for the decoupling capacitors C4 . . . C8.

96

high performance video mixer

find the right combination!

Terminals, (the interfaces between computers and video screens), have to output two synchronisation signals in addition to the actual video signal. The Elekterminal also contains a video mixer which combines the two signals into the single video display control signal. The H and V sync signal control the horizontal and the vertical deflections of the electron beam, respectively, while the video signal incorporates the picture information. All three signals are combined in the mixing stage around T1 and T2.

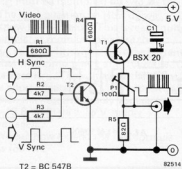

T2 mixes the sync signal; the transistor forms a NOR gate together with R2 and R3. Transistor T1 operates as an emitter follower. P1 sets the amplitude of the output signal, enabling the circuit to be adapted to any type of monitor and/or TV set. A monitor will have to be used, should your TV not have a video input socket. The video combiner is suitable for bandwidths up to 25 MHz.

97

rear light monitor

an effective dashboard monitor

Even though car dashboards are beginning to resemble the control panels inside a cockpit, it is surprising how many LEDs are in fact totally superfluous. What is the point of an LED that indicates whether a switch is on or off, but fails to monitor the actual function of the equipment connected to it? Take the rear fog warning light LED, for instance; it will continue to burn irrespective of whether the light is working properly or not. The only way to check it is to jump out of the car and take a look! The idea behind this circuit is to provide a car monitor system that can be easily installed on the dashboard.

As it only requires five components, it can be fitted behind the existing switch. This is what's required. Break the ground connection (if included) of the switch LED and the connection between the switch and fog light (or any other that is required to be monitored). Now install the circuit as shown in figure 1. There should be plenty of room for the unit in the vicinity of the switch in question. Operation is straightforward: If everything is O.K., the load current will flow to ground via R1 and La1, the fog light. The voltage across resistor R1 will then be sufficient for transistor T1 to conduct and the switch LED to light. Should the bulb La1 fail for any reason, T1 will not receive enough base current and will stop conducting. In that case, T2 will also stop conducting and the LED will go out. The value of resistor R1 may be calculated according to the following formula:

$$R1 = \frac{\text{battery voltage in V}}{\text{lamp power in W}} \cdot 0.6 \Omega$$

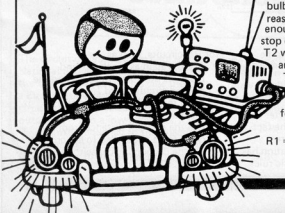
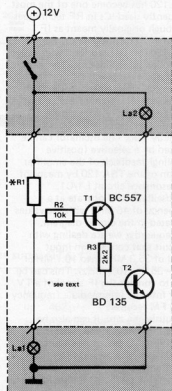

98

connection tester

continuity tester with LED indication

In the April issue of Elektor, we published a circuit for a contact tester with an acoustic indication. As a result of this publication we received a number of requests from readers for a contact tester with an optical indication. The circuit described here fits that particular bill rather nicely. Like the original design this circuit has its own printed circuit, the only difference being that this one uses a LED, rather than a buzzer to denote a good contact.

The theoretical aspects of this circuit were discussed in detail in the April issue so for now we will restrict ourselves to recapping the calibration procedure. Place a 1Ω resistor between the probes and adjust P1 until the LED is just about to light. Remove the resistor and create a short circuit between the probes. The LED should now light. To make sure that calibration is correct, place a resistor of only a few ohms between the probes. If the LED lights up now, the calibration procedure will have to be repeated. After correct adjustment, only resistances of up to 1Ω will be tolerated. A value lower than this will either indicate a good contact or a short circuit. Keep in mind that the supply voltage of the circuit under test should be switched off, otherwise the tester could be damaged. As long as the LED is only allowed to remain lit for short periods, the consumption of the tester will not exceed 8 mA. The battery should last at least a year.

Parts list

Resistors:

R1, R3 = 22 k
R2 = 10Ω
R4, R5 = 1 k
R6 = 470 k
R7 = 1k2

Capacitors:

C1 = $10 \mu/10 V$

Semiconductors:

IC1 = 741
IC2 = 4093
D1 = 3 mm LED red

Miscellaneous:

P1 = 10 k preset
S1 = single pole switch

P.C.M. Verhoosel

1

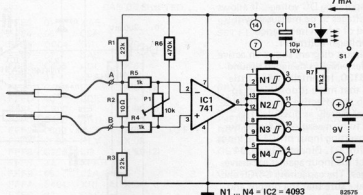

2

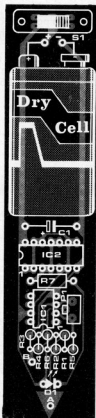
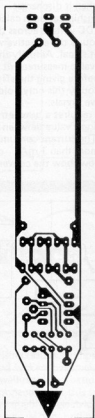

99

AC/DC converter

adapter for DC meters

This AC/DC converter 'translates' the value of an AC voltage into a corresponding DC voltage. It allows AC voltages to be measured with the aid of a high impedance (DC voltage) voltmeter.

The circuit diagram shows an active rectifier which is designed around a CA3130. It contains a few little tricks that make it possible to approach the effective value measurement as closely as possible. The signal to be measured is fed to the non-inverting input of IC1 via input capacitor C1. Diodes D3 and D4 protect the input against excessive voltages. The capacitors C4/C6 and negative feedback are only AC coupled, so that any offset of IC1 will not effect the measurement result. Resistors R1 and R2 look after the DC setting of the IC, while R3 takes care of the DC amplification factor (1x). Bootstrapping is achieved by C2, which considerably increases the input impedance of the circuit. D2 will conduct on a positive edge of the input signal, at which the amplification factor of the opamp is determined by the relationship of the resistors R4, R5 and the setting of potentiometer P1. Capacitor C5 will then be charged via resistor R6. During the negative edge of the input

signal D1 will conduct, causing C5 to discharge again, but only partly, because (a) the gain of the opamp is only 1x when D1 is conducting and (b) because the resistance value across which C5 must discharge is larger than that when it discharges. This relationship has been calculated so that the DC voltage across the capacitor equals the effective value of the input signal. Actually this is an average-value-measurement that is corrected before giving the effective value. Obviously this only holds good for sine wave signals. The circuit requires a symmetrical supply having a value between ± 2.5 V and ± 8 V. The current consumption is slightly more than 1 mA. Figure 2 shows how the converter can

be used with a voltmeter, in fact, the LCD meter published in October 1981 issue. In this case, R1, R2 are a wire link, R8, D1 and D2 are omitted; connect link A. The voltage divider is used for AC as well as DC voltages. The decimal point of the display can be switched by adding an extra contact to switch S1. Since the voltmeter itself produces an artificial 'zero', a 9 V battery will suffice as power supply for the converter. Of course, it is possible to use any voltmeter, as long as its input impedance is 10 M Ω or more.

The LCD meter must be calibrated on the 200 mV range with switch S2a in the DC position before the AC/DC

converter can be set-up. The converter can then be calibrated with the aid of P1, by feeding an AC voltage of approximately 150 mV_{rms} at a frequency of 100 Hz and comparing the read-out with another accurate DVM. The accuracy of the converter is better than within 10% for frequencies ranging from 40 Hz to 1 kHz.

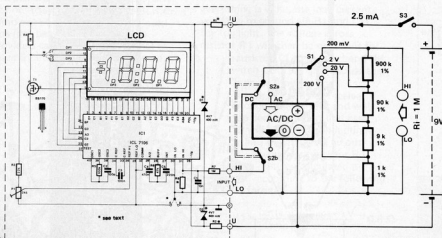
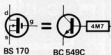
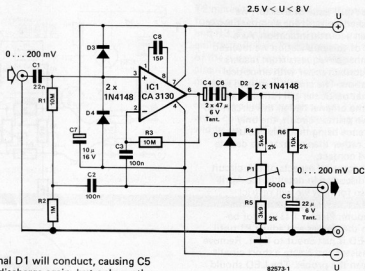

82573-2

100

high speed print routine

for SC/MP

The use of the small circuit described here together with the output routine in table 1, enables the high-speed printing of information from the SC/MP. With the aid of the Elektor terminal, data can be displayed on the screen at a rate of 19200 baud. In effect this means that a 4K 'string' which would normally take 38 seconds to print (at 1200 baud) can now be displayed in approximately 2.5 seconds. display on a VDU at approximately this speed.

In practice the 74LS373 is used in this circuit as a latch and three stage output buffer. The data on the SC/MP bus is latched when the decoding address (in this case 0800 . . . 09FF) and the NWDS are at logic 1, a pulse (between 0 . . . 5 V) is latched. As a result of all this, the UART of the Elektor terminal, is brought into tri-state operation, and the data in the latch is transferred into the output buffer of the 74LS373. The outputs of IC1 and Flag 2 are connected to the Elektor terminal at the pins shown on the circuit diagram. Pins 4 and 16 of the UARTs have to be disconnected.

Table
OUTPUT ROUTINE. JUMP WITH 3F (XPPC 3) CAN BE SHIFTED.

FFE3	01	XAE		SAVE BYTE.
FFE4	06	CSA		SET FLAG 2.
FFE5	DC04	ORI	X'04	
FFE7	07	CAS		
FFE8	C408	LDI	X'08	LOAD OUTPUT ADDRESS.
FFEA	37	XPAH 3		
FFEB	CAE6	ST	X'E6 (2)	SAVE P3 HIGH.
FFED	40	LDE		GET BYTE.
FFEE	C800	ST	X'00 (3)	STORE OP OUTPUT ADDRESS.
FFF0	D460	ANI	X'60	INSTRUCTION OR CHARACTER?
FFF2	9C02	JNZ	X'02	NOT 0, SO CHARACTER.
FFF4	8F08	DLY	X'08	WAIT.
FFF6	C2E6	LD	X'E6 (2)	GET OLD P3 HIGH.
FFF8	37	XPAH 3		
FFF9	06	CSA		CLEAR FLAG 2.
FFFA	E404	XRI	X'04	
FFFc	07	CAS		
FFFD	3F	XPPC 3		BACK TO MAIN PROGRAM.
FFFE	90E3	JMP	X'E3	TO FFE3

F. de Bruijn

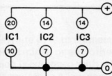
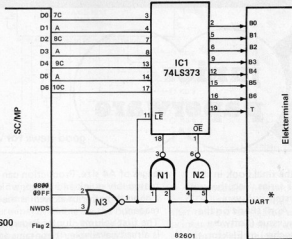

* see text

N1, N2 = 1/2 IC2 = 74LS00
N3 = 1/2 IC3 = 74LS02

101

phase sequence indicator

for three-phase installations

When making connections to a three-phase mains supply, it is often essential to get the three phases in the correct sequence. Otherwise motors, for instance, have a tendency to rotate in the opposite direction - which can

have surprising results. Pumps become suckers, and suckers become . . . forget it. In this well-regulated nation of ours, all connections of this type must be made by qualified electricians, so nothing can go wrong. End of article,

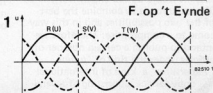

F. op 't Eynde

for those readers who are not qualified electricians.

For those readers who are still with us, the device described here can prove quite useful. In a nutshell, when its three inputs are connected to the three phases (the neutral connection isn't needed for this test), one of two LEDs will light to indicate a clockwise or anticlockwise phase sequence. In this connection (I), 'clockwise' is defined as U, V, W (or V, W, U or W, U, V) and corresponds to the green LED. Anticlockwise, not surprisingly, is the other way 'round'; the red LED will light.

The basic idea can be derived from figure 1. This is a plot of the three phases; as can be seen, at the zero-crossing of one phase the following phase is positive and the third is negative. This is quite easy to detect! To simplify the connections, an artificial 'neutral' is created at the R1/R2/R3 junction. Only two of the phases are then used in the actual measurement; their value with respect to the artificial 'neutral' is detected, and used as follows.

At each negative-going zero-crossing of the voltage at the U input, the flipflop

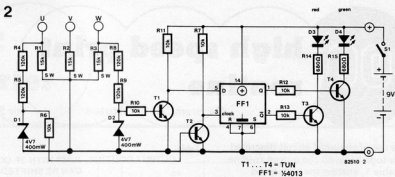

(FF1) clocks in the value at the W input as data. If the phase sequence is 'correct' (clockwise), the W input should be negative at this point — as can be seen in figure 1. This means that T1 is blocked, so that a logic 1 is applied to the D input of the flipflop. The actual clocking of the flipflop is done in a similar way, by means of T2. When the logic is clocked through to the output, T4 will conduct. This causes the green LED to light. If the phases are inverted (anticlockwise), T2 will be conducting at the negative-going zero-crossing of U. This means that a logic 0 is clocked into the flip-

flop. T3 will then conduct, and the red LED will light. Obviously, swapping any two phase connections will convert one phase sequence into the other.

The two zener diodes (D1 and D2) protect the transistors — both against excessive base drive and against negative base voltages.

Two final notes. For safety reasons, the complete unit must obviously be mounted in an insulating (plastic) case; the switch must also be a 'safe' type! Furthermore, battery supply is a 'must': try to imagine what might happen with a mains supply!

junior paperware

good news for Junior Computer fans

Volume four is the final book in the Junior Computer series. Together with the additional system software, published in the April (Basic on the J.C.) and the May issue (Software cruncher and puncher) of Elektor, the books form a very useful library. Obviously there is a lot more new hardware and software for the Junior Computer that could be published! The problem is not *what* should be published, but *how*? Hex dumps and source listings take up a lot of space and we would also like to keep Elektor interesting for readers who do not possess a Junior Computer.

A book is another possibility, but it would take too long and for technical reasons would be too expensive. The ideal solution is to combine the best of the two possibilities and in this way come to a compromise. Therefore we intend to publish a certain number of articles under the title of 'Junior Paperware', a kind of international copy service, consisting of several

pages of A4 size. Production can be reasonably quick and cheap, which is a good thing for us as well as the readers.

The first volume, Junior Paperware 1, is already available. It contains additional information concerning the 'software cruncher and puncher', including the hex dump and source listings.

We have enough material for further 'Paperware' publications. For instance, additional details about the Junior Basic, a text editor/assembler and many other short subjects. Last, but not least, it will contain a lot of programs that have been sent in by industrious readers. Many thanks and keep them coming!

In short, Junior Computer owners will not be able to complain of getting bored.

102

the Elekterminal with a printer

interface with low cost printers

E. François

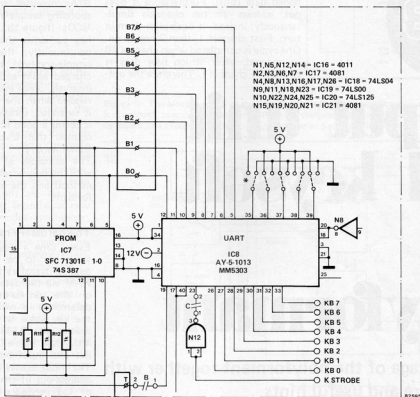

It is quite easy to connect the Elekterminal, or any other terminal which is equipped with a UART, for that matter to a low cost printer. Most if not all low cost printers incorporate what is known as a 'centronics interface'. Basically the reason for this is that Centronics were one of the leaders in the field of budget printers, and as a result their original interface design has been used by a large number of manufacturers as an industry standard. The universally available Epson MX 80 is a prime example. The advantage of using such a printer is that the I/O routines do not have to be altered.

The Elekterminal already has a UART, converting the serial bit output of the computer into a 8 bit parallel code for video RAMs. So, it is just a simple matter of using the same code to drive the printer in parallel.

Link data lines D0 . . . D7 on the printer interface circuit (which forms part of the printer) to connections

B0 . . . B7 on the Elekterminal printed circuit board. It is obvious that there is no B7 terminal available on the board, so a new terminal has to be made up. This can be derived by making a connection to pin 5 of the UART. The next stage is to link up the strobe input of the interface to point T on the Elekterminal.

In some cases the printer may go hay-wire, while the computer will still continue to apply data. This is simply because minor differences may occur as far as the interface specifications are concerned. Should this happen then the following procedure has to be adopted.

- Connect the 'printer' busy line directly to the 'clear and send' line on the serial output port (such as ACIA) of the computer system, and not via the Elekterminal. As a result, the output data will then be kept back, allowing the printer to work without interruption.

- Connect a 4k7 resistor between the CTS line and ground. This ensures that the line is disabled whenever the printer is not in use, allowing the operator to continue work with the computer even when the printer is switched off.

A very important point to keep in mind is that the UART must receive the correct bit pattern from the computer. This should be: 8 bits, no parity and 2 stop bits. Any discrepancy or deviation from this pattern may prevent the printer from acknowledging the most significant bit containing the logic 1 for a character, making the printer virtually useless!

82585



output unit and keysoft for polyformant

the final stage of the polyformant together with the software and useful hints

After the CPU described in the May issue and the 'Polybus' published in last month's magazine it's time to add the finishing touch to the project.

The output unit ensures that each channel receives its respective correct information in the right order, such as control voltage, gate pulse and so on. This is the last unit needed to complete a basic version of a polyphonic synthesiser.

U. Götz and R. Mester

The actual sound generators of the polyphonic synthesiser are still going to be analogue. All ten synthesiser channels consist of voltage controlled circuits (VCO, VCF, VCA). Therefore they require analogue control voltages to determine the pitch, and gate pulses which effectively start and stop the envelope generators. However, the microprocessor in the digital keyboard (on the CPU card), only supplies binary coded data (bits). Furthermore it does not address all ten channels simultaneously; instead, it deals with them in turn. First channel 1, then 2 and so on. One cycle is completed when channel 10 is updated, after which new data is applied to channel 1. Therefore the out-

bus which is fed by the CPU. The allocations of data to the VCO is performed by the 'enable' inputs of the RAMs (used as latches): For example, latch 1 only receives the order WRITE from the CPU when the correct data for VCO 1 is on the bus. A *multiplex procedure with software refreshing* will also work, and it uses less components. The multiplexer, controlled by the CPU, ensures that the voltages supplied by a single D/A converter are fed to the corresponding sample-and-hold stages of the VCOs (figure 1b). However, the CPU has to drive the multiplexer almost continuously; the capacitors of the sample-and-hold stage have to be recharged again and again, at very short intervals. Since every byte is going to be needed when the polyphonic keyboard is extended, (presets keyboard-splitting) it seems a good idea to add a hardware counter that takes care of the 'read' from memory.

The principle of multiplex operation with hardware refreshing, is the third method and the one used for the polyformant.

The hardware refresh cycle

Every time a new key is depressed its value has to be stored in RAM. The counter transfers this key value to the RAM via the data bus. The bit pattern on the address-bus of the computer determines in which memory location the key value is stored. The CPU addresses the RAM via a data selector MUX (see figure 1c). This data selector has two input busses and one output. The input busses are connected to the address-bus of the CPU and the output of the hardware-refresh counter. The logic level on the WRITE line determines whether the computer address-bus or the hardware-refresh counter is connected to the RAM; the CPU addresses the RAM when it writes a key value into memory. The RAM reverts to the 'read' mode once the key value has been stored. The memory addresses are scanned consecutively by the external hardware-refresh counter.

Each VCO is allocated a specific memory location. This means that the multiplexer, (which distributes the D/A converted output), must always drive the same channel, when the corresponding location is read. This permanent allocation is obtained by interconnecting the address inputs of the RAM and the multiplexer. As before, only one D/A converter is required: in this case the Ferranti ZN 426, an inexpensive IC that fits the bill extremely well.

Figure 2 shows the circuit of the output unit and the connections to the bus board on which the D/A converter is mounted. All the necessary connections to the bus should be made by using a multiway plug and socket, in the same manner as the CPU and input unit. IC3 is a BCD which is addressed by inputs A0... A3. It releases the single

put unit forms an essential interface, converting digital data into analogue control voltages and gate pulses. It distributes them to each synthesiser channel in the correct sequence and at the right time. Three completely different principles can be applied to analogue/digital conversion and distribution.

Before describing the circuit of the output unit in detail, a summary of all the possible solutions is interesting.

Static procedure and multiplexing

The block diagram in figure 1a shows that a digital memory precedes each D/A converter; the inputs of all these memories are all connected to one data

latches IC5 1... IC5 10, consecutively. Each latch is in fact released via its 'enable' input every time the respective data for a particular channel is on the bus. The data actually reaches the bus via the driver IC4.

The AND gate N1... N6 take care that the WRITE pulse at pin 11 stores the data at the right time in the latch. The information at the outputs of the latches is permanently available to the D/A converter, therefore eliminating the need for any interruption to allow it to 'read'.

The D/A converter

As already mentioned before, multiplexing with hardware-refreshing, only requires one D/A converter. Unfortunately at the time of going to press, the prototype output unit has not been completed. Therefore, despite the high cost, anyone wishing to build a complete synthesiser will, for the time being, have to build it using the static principle, constructing as many converters as there are VCOs. But do not get alarmed! During the following months a new book on the Polyformant synthesiser, should be published, incorporating all the circuits and information needed for the multiplexing hardware-refresh system using only one D/A converter.

Realising the circuit as shown in figure 1b is not as simple as it may seem!

To keep the costs as low as possible the Ferranti ZN426E-8 was used. It is a very accurate and reliable IC mainly due to its own internal reference voltage source. Each D/A converter circuit will require two of these chips. Even though we are dealing with an 8 bit converter with only four inputs connected, two are required for the following reasons:

The computer determines the keyboard output voltage (KOV) level by comparing two different sets of data. Firstly, which octave, and secondly the number of semitones being called for within that octave. For example code 3.7 could represent the seventh note (F sharp) of the third octave. The word 'could' is in the sentence simply because it is not the real software digital coding used, but only an expression to try to explain the basic principle. The D/A has to decode each octave 1 V at a time, as the VCOs produce 1 octave per 1 V. For the notes within any given octave the voltage supplied to the VCOs changes in one twelfth of 1 V per semitone.

To interface the converter both outputs must be fed to a non-inverting adder, by using two opamps. The other two opamps operate as impedance converters.

Mechanical construction of the output unit

Figure 4 illustrates the way in which each converter board is mounted onto the output unit main board. The construction is basically in the same format as the bus boards. The beauty of this

1a

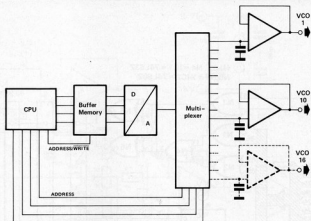

Figure 1a. The block diagram of the output unit, which is straightforward as far as the hardware is concerned. In order to relieve the CPU from the pressure of continually multiplexing the keyboard, the circuit in figure 1a was redesigned as per figure 1b.

1b

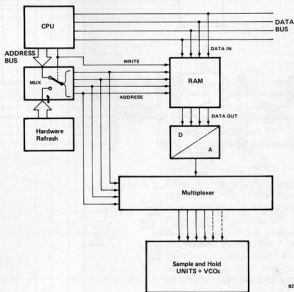

Figure 1b. This circuit has a special feature known as the 'hardware refresh cycle' system. The CPU only reports back when new data is applied to the multiplexer. The rest is taken care of by an external counter, permanently scanning the RAM in a series of cycles, synchronising the multiplexer accordingly.

1c

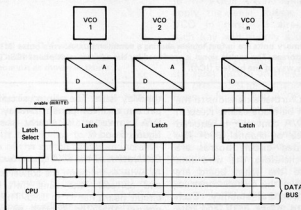

Figure 1c. A simplified format for the circuit shown in figure 2. In spite of the large number of components this circuit (using a separate D/A converter per channel), was selected, in order to avoid various control and synchronisation problems and for reliability.

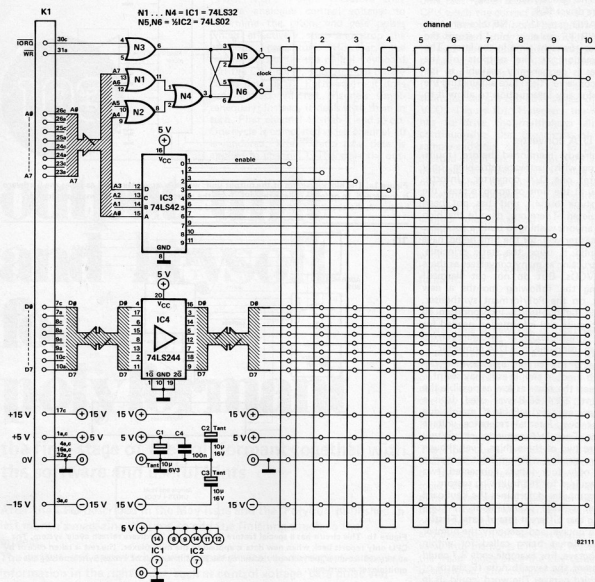

Figure 2. The memory units are in fact latches sharing a common bus. A write pulse (N1 . . . N6) and an enable pulse (logic 1 at pin 1) must be applied for data storage. The enable signal is produced by the address multiplexer IC3. The data for the D/A converter and the gate pulses are sent to the bus by way of the buffers (IC4).

method is that further extensions to the synthesiser can be made easily. Keep in mind that a D/A converter is required for every 'voice' or channel used! The converter printed circuit boards are quite small, therefore the wire link connections to the main board are sufficient to give the overall construction ample structural stability. Each converter board has a KOV and gate pulse output. The method used to connect these to the analogue sections of the synthesiser was described in great detail in the Polybus article published in

the May issue. The printed circuit board pattern and component overlay of the D/A converter is clearly shown in figures 5 and 6.

Calibration of the D/A converter

In order to calibrate the converter easily and correctly the tune shift printed circuit board has to be used. This circuit ensures that the correct digital data from the keys is fed to the D/A boards. Needless to say only one D/A converter at a time can be calibrated.

The first stage in the procedure is to

connect a digital volt meter (DVM) or any accurate instrument to the KOV output and the ground connections of the converter.

We suggest the use of a DVM, as the readings have to be accurate and a digital display is much easier to read than a normal moving coil instrument. Next depress any key of the keyboard, and measure the voltage. Keeping the keyboard key depressed, push down and therefore switch on the first DIL switch of the tuneshift circuit. By the first DIL switch we mean the lower octave switch,

3

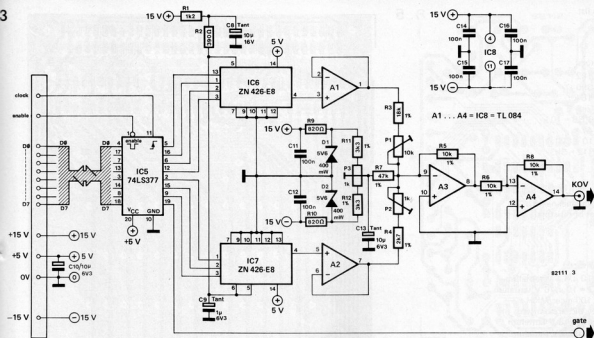

Figure 3. Two Ferranti ZN 426E8 per converter board, per channel. In combination with opamps, the characteristics of the converters are interfaced with the VCOs. P1 tunes the semitones and P2 the octaves. P3 ensures that the VCOs all oscillate at the same frequency when identical control voltages are applied.

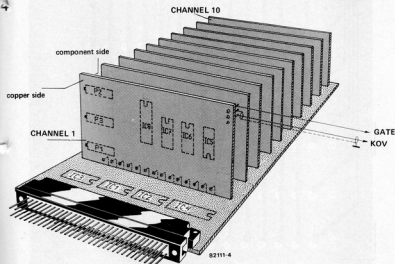

Figure 4. Practical hints on construction. Each channel has its own D/A converter with its corresponding latch, all assembled onto one main board by means of multiway plugs and sockets. The main board also contains the rest of the components as shown in figure 2.

in other words the actual first switch looking at the circuit from left to right. Readers who have not yet built the tuneshift unit should refer to figure 4 of the polyphonic synthesiser article published in the May issue. That diagram shows the DIL switch as being S4. Once again keeping the same keyboard key depressed, switch to the next DIL switch and remeasure the voltage. Figure 4 again in the May issue shows this to be S3.

Preset P2 should now be turned to give an exact difference of 1 V between the

two switching modes. In order to calibrate the semitones of each octave the twelve way switch S1 again part of the tune shift circuit has to be used. Each position of the switch causes an increase of approximately 0,0833 V to the KOV output of the converter. Consequently position number 6 (centre indent) produces an increase or decrease of 0.5 V. P1 is turned until these parameters are met. By adjusting both P1 and P2 in this way all the other octaves and semitones are automatically calibrated. This procedure should be followed closely. It is

not advisable to set P1 before P2 as this will lead to incorrect overall tuning.

The purpose of preset P3

After all the VCOs are aligned, there is still a need for offset compensation. As most readers will already know irrespective of how accurately each VCO is constructed, there are always differences, no matter how small, between identical components. As a result the same voltage level applied to a number of VCOs may produce slightly differing tones. The purpose of P3 is to compensate for this fact. Once the synthesiser has been built, the swapping over or interchanging of converters with the VCOs is also unadvisable.

Now that the keyboard is connected to the VCOs it is no longer possible to apply the same voltage level to each VCO in turn. As already explained each key will supply a different KOV to the VCOs.

Before any attempt is made to set P3, the reset button on the CPU card must be pressed. This is shown as S1 in figure 1 in the Z80-A CPU card article in our May issue. Depress a key of the keyboard. Any key will do but we suggest that it is one in the lower registers like C one octave lower than middle C. Now depress a key exactly one octave higher and turn P3 of the second converter until there is no dischord, (zero beat procedure). Keep in mind that even before you actually do this, P3 on the first converter board has to be set to its mid position. As it is in every case a multiturn preset, the only way to do this is to count the total

Parts list

Resistors:

R1 = 1k2
 R2 = 390 Ω
 R3 = 18 k
 R4 = 2k7
 R5, R6, R8 = 10 k
 R7 = 47 k
 R9, R10 = 820 Ω
 R11, R12 = 3k3

Each channel needs a full set of resistors!

Capacitors:

C1 = 10 μ /6.3 V tantalum
 C2, C3 = 10 μ /16 V tantalum
 C4 = 100 n cer/MKH
 C5 ... C7: are omitted
 C8 = 10 μ /16 V tantalum
 C9 = 1 μ /6.3 V tantalum
 C10 ... C12, C14, C15 = 100 n cer/MKH
 C13 = 10 μ /6.3 V tantalum

C8 ... C15 are required for each channel!

Semiconductors:

D1, D2 = 5.6 V/500 mW zener diode
 IC1 = 74LS32
 IC2 = 74LS02
 IC3 = 74LS42
 IC4 = 74LS244
 IC5 = 74LS377
 IC6, IC7 = ZN 426E8
 IC8 = TL 084

D1, D2, IC5 ... IC8 are needed for each channel!

Miscellaneous:

1 64-pin DIN 41612 A/C connector

5

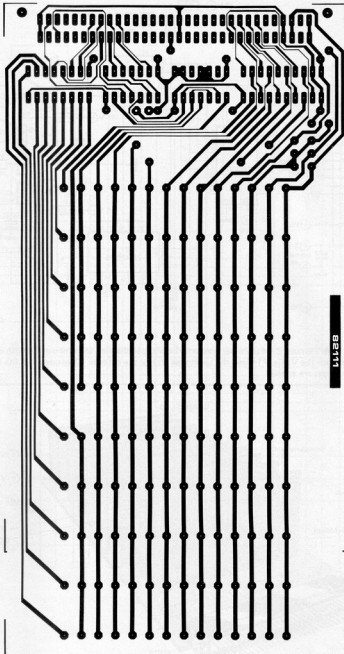

Figure 5. The component overlay and track pattern of the output unit.

number of turns. The next stage is to reset the CPU once more, press any key, then depress in quick succession a second and third key, releasing only the first. Ensure that the second and third key are one octave apart and turn P3 on the third converter board until there is no dischord. Continue to progressively repeat this procedure until all ten channels are in tune.

Practical hints for aligning the VCOs

Although the procedure for aligning the VCOs was gone into in great depth in our June issue, it is worthwhile to not

only recap on certain points but to add further useful hints.

By the way, it is hoped that constructors have read through and implemented the VCO calibration procedures outlined in all the previous articles, otherwise the D/A converter calibration procedure as well as the rest of this article will be either difficult or impossible to follow.

Irrespective of how accurately the VCOs have been aligned up to now, once they are inserted into the complete synthesiser a number of tuning deviations or errors will be apparent. The following procedure is aimed at eliminating

these differences in order that it can be played. One of the most difficult problems, once all the VCOs, converters, and other circuits are assembled, is to determine which VCO is being fed to the output at any given time. To get over this problem we suggest the following:

Firstly, only one complete channel has to be mounted onto the bus board. This will consist of a VCO, VCA and ADSR. We call this first VCO the master channel. An accurate alignment of this channel can then be used as a bench mark for all the others. Obviously when assembling this channel all the control-

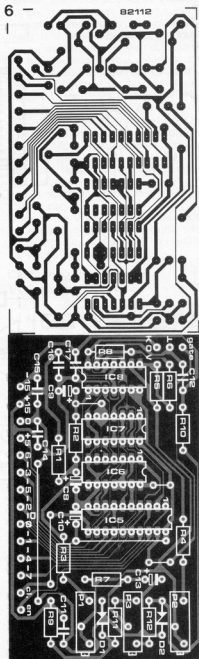
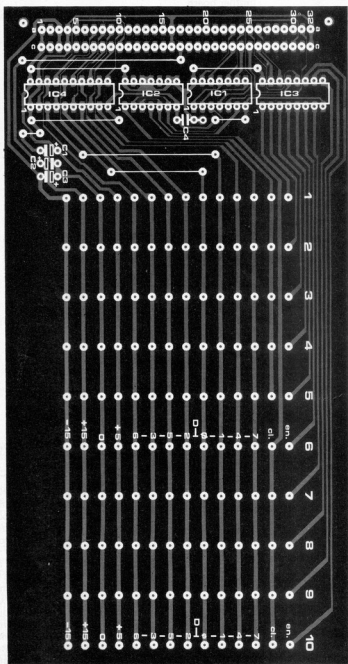

Figure 6. The component overlay and track pattern of the main D/A converter board.

ling potentiometers and switches on the front panel must also be connected up. An artificial gate pulse signal has to be supplied to the envelope generator so that a VCO signal is fed to pin 27 of the bus board. Feeding +5 V from the power supply to pin 30 of the bus is sufficient for this. A continuous signal from the VCO is also necessary. This is easily achieved by setting the front panel controls. The sustain levels for both the VCA and VCF must be set to maximum, with the attack controls set to minimum. The cut-off must be as high as possible, and the emphasis (Q) set to minimum. A saw-tooth type signal from

the VCO is ideal for the calibration procedure.

The article in the December issue already mentioned the fact that the 'linearity' of the VCO can be set with P9 remembering that P1 was removed. The next step is to supply an adjustable control voltage to the same input, of the VCO where the KOV would normally be attached. This voltage, which has to be of high precision can be generated in a number of ways. The choice of how to get it is left to the constructor, but please keep in mind that it has to be graduated into steps of 1 mV. A good method for accurate control is to use

two potentiometers together with an adder (see figure 7). One potentiometer being used for the rough, the other for the fine adjustment.

The use of an accurate digital voltmeter, in order to monitor the control voltage, should also be connected to pin 28 of the bus board (KOV input of the VCO). Finally a reference tone is needed, either from a stable tone generator or from an electronic organ.

Set the (auxiliary) control voltage source to exactly 1 V. The amplified output of the synthesiser, fed to a loudspeaker, should produce a low tone. Adjust the near equivalent reference tone, until it is

7 mother board

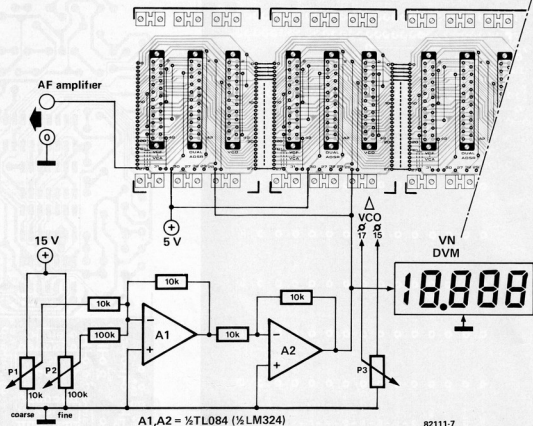

Figure 7. A suggestion on how to calibrate the VCOs. Mount two channels connecting all the gate inputs to +5 V. Link all the KOV inputs to the auxiliary control voltage circuit, giving accurate control down to the last mV (see text).

the same as that of the VCO. Now increase the control voltage by 1 V. The control voltage has to be accurate to within 1 mV. By increasing the voltage in this way the VCO should now produce a new tone exactly one octave higher than the first one. Unfortunately this will not always be the case. Therefore using the same reference tone once again, P9 must be readjusted until the VCO tone is one more in harmonic unison.

Now reduce the control voltage back to 1 V. In all probability the VCO tone produced will no longer be in unison with the original reference tone. The reference tone has to be readjusted accordingly. By increasing the voltage by 1 V the tone one octave higher could now be out of synchronisation with the reference tone, but this time the difference being smaller. Again reset P9. Unfortunately this procedure has to be repeated several times until there are no deviations between the two different tones. This calls for a great deal of patience, but you should find that the differences get progressively smaller each time the control voltage is changed. The whole procedure should now be repeated for higher control voltage levels. After each minor adjustment to P9, you must return to the 1 V tone for comparison. Remember the wider the

voltage range used for calibration, the higher the tuning accuracy.

Unfortunately there are no short cuts to this procedure, and we hope that constructors will bear with us.

Obviously continuing to use one reference tone will make the tuning of the higher octaves extremely difficult. It therefore follows that using an electronic organ for the reference tone would make life much easier, the constructor only has to use each corresponding octave tone on the organ. Then by changing the reference tones in this way instead of trying to ascertain whether a note is in harmony it is a simple matter of ensuring it is in unison. Anyone not able to lay hands on an electronic organ, can easily construct a signal generator that will do the trick.

An oscillator, with its output connected to a multi-stage TTL or CMOS divider (J.K. Master-slave flipflop as 2:1 divider), should be sufficient, after all an organ works on the same principle.

Aligning the other VCOs

The simplest way to align all the other VCOs, is by ensuring that they produce exactly the same tone as the master channel when an identical control voltage is applied to them.

First mount the second channel onto the second bus board. Again the gate

pulse input will require 5 V. Pin 28 of the second bus must be connected to pin 28 of the first, so that the auxiliary control voltage (ACV) is also supplied to the second VCO. Start again with a control voltage of 1 V approximately. VCO number 2 will now oscillate at a different frequency to the master. In order to simplify the complete alignment procedure a further adjustable auxiliary control voltage (ACV) is also required. This is connected to pins 17 and 15 of the VCO, and obtained from the auxiliary voltage circuit as shown in figure 7. P3 of this circuit adjusts the voltage level for this extra supply. P3 in effect is a kind of off-set compensator. It acts not only as P3 in the D/A converter circuit but also as the old P1 (now removed) from the original VCO board.

Before going into detail, we should explain that the object of the exercise is not to attempt, at this stage, to ensure that the other VCOs oscillate on the same frequency as the master when applying the same ACV. As already explained in the D/A section of the article this will happen only when the off-set adjustments to each D/A converter have been made. The idea is to linearise the VCOs. In other words, ensure that the rate of increase in frequency of each VCO (in proportion

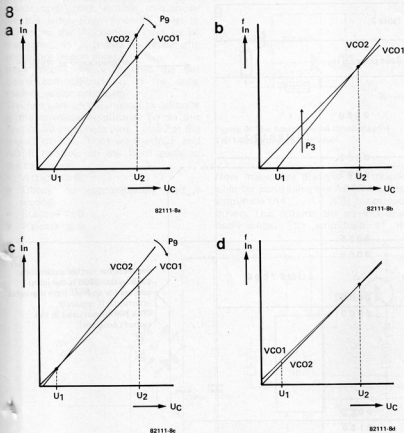

Figure 8. A treat for mathematicians. By alternatively altering the off-set voltage a VCO can be linearised with the master in a series of steps.

to the increase of the ACV), is the same as the master. Looking closely to figures 8a...8d, whilst carrying out the calibration procedure should clarify this limited explanation. The only practical method, without using an expensive frequency counter, is to supply the same auxiliary control voltage to both VCOs, adjusting P3 to offset for component tolerances and then setting P9 of the second VCO until the VCOs are in unison.

This procedure is repeated several times for differing control voltages until both VCOs are in unison, irrespective of the control voltage, and obviously without having to make any further changes to the positions of P3 and P9.

The procedure now has to be repeated again and again for all the other VCOs.

The function of P7

Whereas P9 sets the correct voltage to octave relationship, and therefore the slope of the curve (see figure 8), it does not alter the voltage to pitch characteristics of the VCO, which remain as a straight line. The curve of this latter relationship (depicting the linearity of the two VCOs) tends to bend at very high frequencies. In other words, there will be some deviation between the two VCOs being tuned in the higher octaves no matter how well both P3 and P9 are

adjusted, (Elektor December issue '81). The straightening of this curve and therefore the bringing into line of the VCOs in these higher registers, is achieved by adjusting P7. The best way is to apply an auxiliary control voltage of 7 V and adjust P7 until the VCO in question is in unison with the master VCO and the reference tone for that octave.

Figure 8 illustrates the mathematical background to the calibration procedure.

The starting point of the curve on the X and Y axis, depicts a VCO frequency corresponding to 0 V control voltage. At 0 V the frequency of any VCO will not be exactly 0 Hz, and as already explained whatever the frequency is, it will be different for each VCO. Figure 8a shows the curve of a calibrated VCO (1), and one that is not (VCO2). The correct alignment is defined by the rise of the curve, the off-set not being important at this stage, since it is catered for by the D/A converter. This results in a shifting of the curve towards the Y axis. It is therefore crucial that VCO2 is aligned so that its curve is in parallel to VCO1. The absolute zero point of the curve cannot be determined, because there is no accurate method of measuring zero Hertz.

U1 and U2 are the auxiliary control voltage levels of 1 and 5 V. Figure 8a

indicates a difference in frequency between the VCOs at 5 V. By adjusting P9 the result is that the first curve is rotated around its zero crossing. The result is shown in figure 8b. Although the curves still intersect their differences are now much smaller. Looking at the behaviour of the VCOs at 1 V, shows again a difference in the frequencies. Using P3 (see figure 7) will now bring the two VCOs into line, but obviously causing a further difference at 5 V (see figure 8c). This as previously explained in the alignment procedure can be adjusted once again by using P9. The object of figure 8 is to show in mathematical terms how the alignment procedure actually works, when taking it step by step.

Once all the VCOs are tuned the auxiliary control voltage circuit together with P3 (not confusing it with P3 on the D/A converter) can be removed.

Calibrating the VCF and VCA modules

Correct calibration of the VCAs and VCFs is just as important as the alignment of the VCOs. With the same input voltage applied all the filters must have identical cut-off frequency levels and all the VCAs must have the same gain. If these parameters are not adhered to then the notes would alter in pitch and volume when being played. It is advisable to look at the circuit diagram of the VCA and VCF module published in the January issue, before embarking on any calibration procedure.

First of all earth the wiper of P3. Then set P7 on the master board until the lowest note on the keyboard just becomes inaudible, and measure the voltage across P7. The next step is to set P7 of all the other VCFs to the same voltage (as just measured). In the prototype this voltage was found to be -8.05 V. Now turn P3 fully (this gives 15 V), and set the emphasis (Q) of the filter to maximum. This will cause the cut-off frequency network to oscillate audibly. P9 must now be adjusted until this oscillation becomes just inaudible.

The first filter to be calibrated can now serve as the master, used as a reference for all the others. In order to do this some constructional alterations must be made first. Obviously the first stage is to mount both the master channel and the completed second channel onto the bus board. Next sever the connection to the envelope generator, by taking out the connection from pin 1 to pin 2 at the socket of IC4. So that both channels can apply their signals to pin 27 on the bus-board each VCA must be enabled logic '1' at the gate input. The sustain of the envelope generators must also be set to maximum.

When all the above actions have been completed the two filtered signals can be heard by connecting an amplifier to pin 27 of the bus board. The frequency of the resonance peak of the second channel can be brought into line

Table 1

0	1	2	3	4	5	6	7	8	9	A	B	C	D	E	F
000:	C3	21	01	06	00	00	00	00	00	00	00	00	00	00	00
010:	00	00	00	00	00	00	00	00	00	00	00	00	00	00	00
020:	00	00	00	00	00	00	00	00	00	00	00	00	00	00	00
030:	00	00	00	00	00	00	00	00	00	00	00	00	00	00	00
040:	00	00	00	00	00	00	00	00	00	00	00	00	00	00	00
050:	00	00	00	00	00	00	00	00	00	00	00	00	00	00	00
060:	00	00	00	00	00	00	00	00	00	00	00	00	00	00	00
070:	00	00	00	00	00	00	00	00	00	00	00	00	00	00	00
080:	00	00	00	00	00	00	00	00	00	00	00	00	00	00	00
090:	00	00	00	00	00	00	00	00	00	00	00	00	00	00	00
100:	00	00	00	00	00	00	00	00	00	00	00	00	00	00	00
110:	45	25	31	FF	8F	1B	7A	81	C2	25	61	21	FF	0B	F9
120:	28	31	FF	8F	1B	7A	81	C2	25	61	21	FF	0B	F9	0D
130:	09	05	04	05	03	08	04	79	FE	09	CA	NA	05	03	08
140:	45	25	31	FF	8F	1B	7A	81	C2	25	61	21	FF	0B	F9
150:	09	05	04	05	03	08	04	79	FE	09	CA	NA	05	03	08
160:	00	00	00	00	00	00	00	00	00	00	00	00	00	00	00
170:	00	00	00	00	00	00	00	00	00	00	00	00	00	00	00
180:	00	00	00	00	00	00	00	00	00	00	00	00	00	00	00
190:	23	10	FC	21	00	00	34	45	08	AF	77	3C	23	10	F9
1A0:	22	0A	08	3E	FC	21	4B	08	0A	77	23	10	FC	20	F9
1B0:	56	10	C2	13	03	21	FD	08	36	01	23	23	38	01	23
1C0:	00	23	36	10	23	38	06	23	36	09	23	38	06	23	36
1D0:	23	36	06	23	36	17	38	06	D3	10	3E	20	D3	11	3E
1E0:	D3	11	3E	00	00	00	08	08	0A	CA	04	D2	11	F9	08
1F0:	06	12	ES	04	77	FE	0E	20	10	FE	0A	CA	04	77	FE
200:	CA	7A	03	78	FE	06	CA	19	03	CD	FD	03	CD	FD	03
210:	FD	03	F1	FE	04	28	1E	88	77	0E	00	00	00	00	00
220:	FE	09	CA	43	0D	85	FE	89	CA	52	47	0D	82	8E	86
230:	FE	09	CA	43	0D	85	FE	89	CA	52	47	0D	82	8E	86
240:	FE	09	CA	43	0D	85	FE	89	CA	52	47	0D	82	8E	86
250:	20	14	FE	06	7A	03	24	28	FE	0A	FA	8D	02	28	32
260:	21	AF	02	22	FE	0E	34	28	0B	0E	00	00	00	00	00
270:	C3	E2	01	21	9F	02	22	FE	08	21	F8	08	28	FE	02
280:	FE	8D	77	23	10	FC	21	01	21	86	28	FE	08	28	FE
290:	18	04	3A	F8	08	EE	80	32	F8	08	D3	13	C3	E2	01
2A0:	0A	28	FE	F2	60	02	21	CB	02	22	F6	08	21	F8	08
2B0:	0F	06	08	28	02	0E	FE	7E	D3	13	C3	E2	01	21	9F
2C0:	A6	02	FE	0A	FA	E2	01	28	C9	18	95	FE	0A	28	C3
2D0:	01	18	CB	08	28	EE	80	32	FE	08	D3	13	C3	E2	01
2E0:	18	04	3A	F8	08	EE	80	32	FE	08	D3	13	C3	E2	01
2F0:	02	04	18	CB	F9	79	07	07	86	32	FA	08	28	08	EE
300:	CA	FC	02	06	F8	00	82	78	47	C3	23	10	FC	20	F9
310:	C3	EC	01	CD	FD	03	C3	19	1A	3A	F8	08	47	EE	70
320:	70	CA	09	02	AF	07	07	86	32	FA	08	28	08	EE	70
330:	99	02	81	CA	02	9E	F1	F2	09	09	CB	76	CA	09	02
340:	0D	0F	0F	0F	11	86	0F	16	17	78	80	80	67	06	18
350:	07	28	FA	8E	10	77	23	05	F2	03	01	03	12	08	12
360:	ED	A2	20	FB	03	03	C3	13	02	0B	11	21	F8	08	8E
370:	28	99	23	77	CD	FD	03	08	11	21	F1	08	8E	20	3C
380:	8E	28	77	8E	10	77	23	05	F2	03	01	03	12	08	12
390:	47	FB	E5	0F	FE	0A	F2	CB	03	E1	28	FE	F1	F2	CB
400:	03	28	28	10	3D	07	CB	20	1F	0F	0F	0F	0F	0F	0F
410:	0F	F3	10	67	8E	80	84	E2	22	F2	2A	03	00	00	00
420:	0E	11	ED	41	78	03	10	88	ED	41	85	05	00	00	00
430:	C1	E1	CB	ED	41	23	05	78	FE	20	FE	02	83	06	00
440:	0E	11	ED	41	20	F8	03	03	C1	20	0B	01			

Table 2

Basic program layout

0000	.	JUMP0122
0002	.	
0003	.	
0065	.	
0066	.	JUMP2000
0068	.	
0069	.	
00ED	.	
0100	.	
01E2	.	NOP
01E3	.	NOP
01E4	.	NOP
01E5	.	
04FA	.	NOP
04FB	.	NOP
04FC	.	NOP
04FD	.	
07FF	.	

← program entry at 'RESET'

available for further extensions (235 bytes) 0066 is the jump address for an NMI (non maskable interrupt), if required. (The NMI is not used in the keysoft program).

1

- The keysoft program (keyboard controller plus preset).
- The NOPs may be replaced by jump instructions, if the program is extended (for example 01E2 ... 01E4 may contain a jump to 0003 and 00ED return to 01E5).
 - Ⓞ is run every 42 milliseconds (approximately)
 - Ⓟ is run every 2 milliseconds (approximately)
 - Use Ⓞ whenever possible, as otherwise the keyboard controller program may be slowed down considerably.

2

with the first by adjusting P9, in other words until both audible frequencies are the same. Even when P3 is set to minimum the frequencies have to be the same, so it is best to repeat the procedure several times.

Now mount the VCF onto the bus board and calibrate it in the same manner as just described.

The last part of the channel to calibrate is the envelope amplitude. To do this first of all reconnect pins 1 and 2 at the socket of IC4. Then set the VCF and ADSR controls on the front panel to the following:

- 'Attack' to 0.
- 'Decay' to approximately half a second.
- 'Sustain' to 0.
- 'Release' to 0.

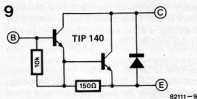

Figure 9. The basic internal structure of a TIP 140 Darlington transistor.

Now make sure that the VCA responsible for controlling the ADSR envelope for amplitude (A4...A7, IC6) is not overdriven. This requires the services of an oscilloscope. The amplitude of the

ADSR envelope can be measured by connecting the oscilloscope to the output of A7. Whenever a gate pulse is applied (starting with the master channel) a waveform will be illustrated by the oscilloscope. P11 should be set so that the amplitude is at maximum (with a steep decay), without experiencing and clipping, otherwise the instrument cannot produce any staccato-type sounds. With clipping, (overdriving the VCA), the output voltage will remain saturated for a while, even though the signal is already decaying, so the setting of P11 is very important. We suggest the procedure is repeated several times with differing decay times.

With a zero setting of the attack time and sustain, typical, electronic sound effects can be heard! Once P11 is

10

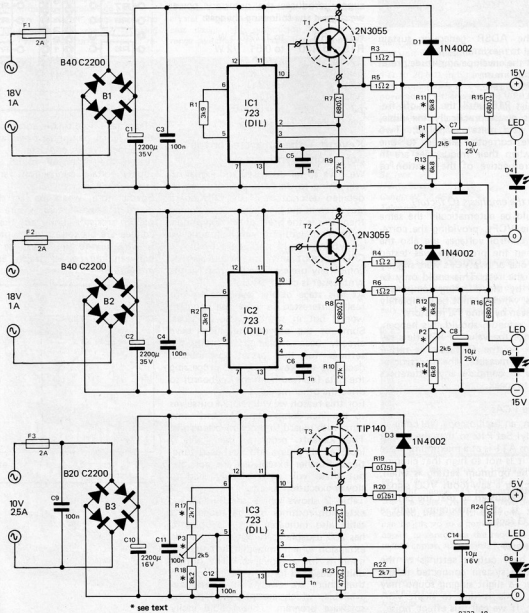

Figure 10. The circuit diagram of the Formant power supply. All the component changes are included.

calibrated P10 must be adjusted so that all the filters give the same frequency change with identical envelope amplitudes. Again we advise doing this by ear, comparing them with the master. The easiest way is to use only the first two channels, inserting each module in turn into the second channel, calibrating them one at a time.

It is also advisable that the gate pulses should be produced manually and independent from the keyboard. Connect the gate inputs to a DC supply of 5 V, using a press button switch. As already mentioned, the channel assignment in the computer controlled keyboard is based on criteria relating to an average musician's playing style. It therefore would confuse the issue, if we tried to apply gate pulses or VCO control voltages to any specific channel by depressing a key.

Setting P10

- Set the ADSR generator sustain control to maximum.
- Adjust the envelope amplitude preset P5 to maximum.
- Turn P3 to zero.

Now adjust P10 until the cut-off frequency is again practically inaudible, (when a gate pulse is applied). Two filters are correctly aligned to one another when their frequencies are in unison irrespective of the position of P5.

Adjusting the emphasis (Q factor)

This should be automatically the same for all the VCFs, providing the corresponding control voltages are also the same. When the prototype was tested however, one or two VCFs were slightly out with the rest. This could only be explained by the differing component tolerances, which cannot be completely avoided, even by using 1% resistors.

The only remedy, should this happen, is to change the value of R24 (lets say to 86k). As the Q factor is rather difficult to measure, the constructor will have to compare any differences by ear so to speak.

Setting the VCAs

Here again, an oscilloscope will come in very handy! Set P12 so that the output signal from A11 is at a maximum. Make sure that it is not so high that clipping occurs. The optimum setting is when, after selecting a saw-tooth VCO signal, the filter is adjusted so that the cut-off frequency is at a maximum with a minimum Q factor.

VCA cross-over

At very high output settings of the amplification system connected to the synthesiser, a slight singing sound may be heard. This is due to slight VCA cross-over. If we call this effect 'noise', then it really is nothing to worry about, since the signal-to-noise ratio of the instrument is so good that this cross-

over is hardly noticeable. Should you really wish to eliminate this occurrence then it can be achieved quite simply by inserting a 47 k resistor between pin 10 of A8 and the negative supply.

Driving the VCF inputs

For the VCFs to self oscillate properly, the wire link between point 1 and point 7 on the VCF board should be replaced by a 470 k resistor. This improves the timbre of the individual filters considerably, making calibration easier.

Modifications required when using the Formant power supply

In the article on the bus board we suggested that the Formant, although not being completely compatible, could be used for the polyphonic synthesiser. To ensure that the original Formant supply produces the necessary power we suggest the following changes:

R3 ... R6	to 1Ω/2/0.5 W
R19 and R20	to 0.51 Ω/2 W
R7, R8	to 680 Ω
R9, R10	to 27 k
R21	to 22 Ω
R23	to 470 Ω
T3	to TIP 140.

See figure 9.

Keysoft — the software for the polyphonic synthesiser

We have so far discussed and explained everything to do with the hardware. A detailed description of the CPU board was given in the May issue. As explained then, this is the brain of the polyphonic synthesiser without which practically everything would not work. In turn a CPU without software would also be completely useless. The program for the synthesiser is called 'keysoft'.

At this stage of the game we are not really interested in how the program works, but in what it actually does. Some of the program functions have already been explained; scanning the settings for the 'preset' parameters, decoding the keyboard, and processing the data (derived from the keyboard) to drive the other modules.

For this reason we will restrict ourselves to the 'hex dump' (table 1) and some hints with regard to program extensions. The keysoft program (see table 1) includes all preset and keyboard functions. Further extensions are possible, but these will automatically lead to slower execution speeds.

Table 2 shows where the 'jumps' for extension routines can be added. The table also indicates that the operator has 235 usable spare bytes. A possible extension which immediately comes to mind is for a sequencer! The output unit is designed for up to 16 channels, so that there are always six spare ones available, which are not used by the software program. These could easily be used for the sequencer, provided the necessary software was available! Well later on perhaps!

Epilogue

During the development of extensive projects such as the polyphonic synthesiser changes and modifications are bound to take place from time to time. Fortunately some if not all of the changes have been made before the construction of the prototype was completed. This means, certainly for you at any rate, that changes and modifications can be made during construction. The following points need clarification, and we suggest that the constructor refers to figure A.

A

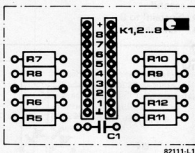

82111-L1

Please take note that in contradiction to the original component overlay of the debounce unit contacts 1...8 are drawn the other way round, but the supply voltage connections remain the same.

Furthermore, when the last debounce board is sawn in two, ensure that the pull-up resistor links to the supply voltage are broken or interrupted. That is why a wire link must be inserted between the copper tracks as shown in figure B.

B

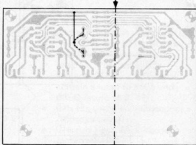

82111-L2

market

Selective call device

Allowing immediate access to four thousand and ninety six independent codes via three sixteen way panel switches, the new Datong 'Codecall' adds selective calling facilities to any existing transceiver yet requires no modifications to the set.

Each pocket size 'Codecall' unit can both send and receive a specially coded audio signal. At the transmitter no direct connection at all is needed. Instead 'Codecall' is placed close up to the microphone and the signal is acoustically coupled. Any convenient transmitter can therefore be used.

At the receiver 'Codecall' plugs into the external loudspeakers jack thereby silencing the receiver. When the correct code is re-

ceived 'Codecall' emits a loud beep-beep sound to alert the user. Unplugging 'Codecall' then allows the set to be used in the normal way. The need to unplug can be avoided by controlling an external speaker with 'L.S. OFF' switch. Long life from the internal PP3 battery is aided by automatic power down circuitry which eliminates battery drain during standby (receiver squelched) while ensuring that 'Codecall' is always alert for the correct code when a signal is received.

Datong Electronics,
Spence Mills,
Mill Lane,
Bramley,
Leeds LS13 3HE.
Telephone: 0532-552461

(2295 M)

Handheld DMM

The 2033 low cost handheld DMM includes .5% basic DC accuracy, large 3½ digit liquid crystal display, an attractive yet rugged new case design with pushbutton function and range switches, easy access battery compart-

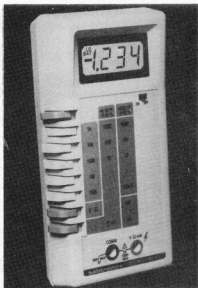

ment, and tilt stand.

The unit will measure AC or DC voltage from 100 μ V to 1000 V in 5 ranges, ohms from 1 Ω to 20 M Ω in 5 ranges and AC or DC current from 10 μ A to 2 amps in 3 ranges, and is powered by either a single 9 V PP3 battery or an optional AC adapter. An optional high voltage probe is also available as an accessory. The model 2033 comes fully assembled, complete with test leads.

Black Star Ltd.,
9 A Crown Street,
St. Ives,
Huntingdon,
Cambs PE17 4EB.
Telephone: 0480-62440

(2296 M)

Logic scale records waveforms

Stotron's new logic scale is a simple, efficient method of recording timing charts, providing a permanent record of waveforms for engineers and designers working on logic circuits.

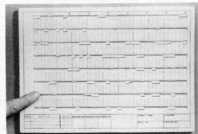

The scale has a series of sliders which can be set to represent clock pulses, and a maximum of eight signals can be represented on each A4 size scale. Once these have been set, and checked, the scale, which is only 7 mm thick, can be placed in a conventional office photo copier to reproduce the required number of record copies. Afterwards it can be re-used.

Stotron Ltd.,
Unit 1,
Haywood Way,
Ivyhouse Lane,
Hastings,
East Sussex.
Telephone: 0424-442160

(2298 M)



TRANSISTORS SURVEY: AF and general-purpose types.

type	PNP NPN	max U _{CEO} (V)	max I _c (mA)	P _{max} (mW)	h _{FE} /I _c (mA)	compl.	fig.
BC 107	N	45			>110	2	BC 177 1
BC 108	N	20	100	300			BC 178 1
BC 109	N	40					BC 179 1
BC 140	N	20					BC 160 1
BC 141	N	60	1000	3700	>40	100	BC 161 1
BC 160	P	40					BC 140 1
BC 161	P	60					BC 141 1
BC 177	P	45					BC 107 1
BC 178	P	25	100		>70		BC 108 1
BC 179	P	20			>110		BC 109 1
BC 182	N	50					BC 212 2
BC 183	N	30			>100		BC 213 2
BC 184	N	50					BC 214 2
BC 212	P	30	200		>60		BC 182 2
BC 213	P	30		300	>80	2	BC 183 2
BC 214	P	30			>140		BC 184 2
BC 237	N	45					BC 307 2
BC 238	N	20	100		>110		BC 308 2
BC 239	N	20					BC 309 2
BC 307	P	45					BC 237 2
BC 308	P	25	100		>70		BC 238 2
BC 309	P	20					BC 239 2
BC 327	P	45					BC 337 2
BC 328	P	25					BC 338 2
BC 337	N	45	500	800	>100	100	BC 327 2
BC 338	N	25					BC 328 2
BC 414	N	50	100	300	>100		— 2
BC 416	P	50			>120	2	— 2
BC 516	P	30	400	625	>30.000	20	BC 517 2
BC 517	N	30					BC 516 2
BC 546	N	65					BC 556 2
BC 547	N	45			>110		BC 557 2
BC 548	N	30					BC 558 2
BC 549	N	30					— 2
BC 550	N	45	100	500	>200		— 2
BC 556	P	65				2	BC 546 2
BC 557	P	45			>75		BC 547 2
BC 558	P	30					BC 548 2
BC 559	P	45					— 2
BC 560	P	45			>125		— 2
BC 639	N	80	1000	1000	>40	150	BC 640 3
BC 640	P	80					BC 639 3

type	PNP NPN	max U _{CEO} (V)	max I _c (A)	P _{max} (W)	h _{FE} /I _c	compl.	fig.
BD 131	N		3	15		0,5A	BD 132 4
BD 132	P	45					BD 131 4
BD 135	N						BD 136 4
BD 136	P	60					BD 135 4
BD 137	N		1	8	>40	0,15A	BD 138 4
BD 138	P	60					BD 137 4
BD 139	N						BD 140 4
BD 140	P	80					BD 139 4
BD 169	N		1,5	20			BD 170 4
BD 170	P						BD 169 4
BD 183	N		15	117	>20	3 A	BD 234 4
BD 233	N	45					BD 233 4
BD 234	P						BD 236 4
BD 235	N	60					BD 235 4
BD 236	P		2	25		0,15A	BD 238 4
BD 237	N	80					BD 237 4
BD 238	P						BD 240 6
BD 239	N		2	30		0,2 A	BD 239 6
BD 240	P						BD 242 6
BD 241	N		3	40	>25	1 A	BD 241 6
BD 242	P						BD 244 6
BD 243	N	45					BD 243 6
BD 244	P		6	65	>30	0,3 A	BD 246 7
BD 245	N						BD 245 7
BD 246	P		10	80	>40	1 A	BD 250 7
BD 249	N						BD 249 7
BD 250	P		25	125	>25	1,5 A	BD 436 4
BD 435	N	32					BD 435 4
BD 436	P						BD 438 4
BD 437	N	45			>85		BD 437 4
BD 438	P						BD 440 4
BD 439	N	60	4	36		0,5 A	BD 439 4
BD 440	P						BD 442 4
BD 441	N	80			>40		BD 441 4
BD 442	P						BD 644 7
BD 643	N	45					BD 643 7
BD 644	P		8	62,5		3 A	BD 646 7
BD 645	N	60					BD 645 7
BD 646	P						BD 676 7
BD 675	N	45			>750		BD 675 4
BD 676	P						BD 678 4
BD 677	N	60	4	40		1,5 A	BD 677 4
BD 678	P						BD 680 4
BD 679	N	80					BD 679 4
TIP 31	N		3	40			TIP 32 6
TIP 32	P						TIP 31 6
TIP 33	N	40			>20	0,5 A	TIP 34 7
TIP 34	P		10	80			TIP 33 7
TIP 35	N						TIP 36 7
TIP 36	P		25	125	>25	1 A	TIP 35 7
TIP 41	N						TIP 42 6
TIP 42	P		6		>20		TIP 41 6
TIP 122	N						TIP 127 6
TIP 127	P	100		8		0,5 A	TIP 122 6
TIP 142	N				>1000		TIP 147 7
TIP 147	P		15	125		5 A	TIP 142 7
TIP 2955	N						TIP 3055 7
TIP 3055	P	70			100		TIP 2955 7
MJ 2955	N						MJ 2955 5
MJ 2955	P				115	4 A	MJ 2955 5
2N 2955	P	25	100 m	0,3	>20	10 mA	— 7

Notes:

1) darlington

2) max. U_{CEO}:

... A = 60 V

... B = 80 V

... C = 100 V

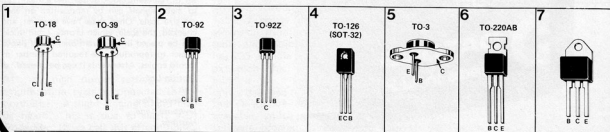

COMPONENTS GROS & PARTS

**FORGET
YOUR PEN
RING 5 TO 10
IT'S COMPONENT
MAIL ORDER MADE EASY
OUR NEW SALES NO.**

567-8910
FIVE • SIX • SEVEN • EIGHT • NINE • TEN
(01 URBAN LONDON)
THE NUMBER YOU CAN'T FORGET

**ALL PRICES
EXCLUDE VAT**

THE MULTI-PURPOSE TIMER HAS ARRIVED

Now you can run your central heating, lighting, hi-fi system and lots more with just one programmable timer. At your selection it is designed to control four mains outputs independently, switching on and off at pre-set times over a 7 day cycle, e.g. to control your central heating (including different switching times for weekends), just connect it to your system programme and set it and forget it—the clock will do the rest.

FEATURES INCLUDE:

- 0.5° LED 12 hour display.
- Day of week, alarm and output status indicators.
- 4 zero voltage switched mains outputs.
- 50/60Hz mains operation.
- Battery backup saves stored programmes and continues time keeping during power failures. (Battery not supplied).
- Display blanking during power failure to conserve battery power.
- 18 programme time slots.
- Powerful "Everyday" function enabling output to switch every day but use only one time slot.
- Useful "sleep" function—turns on output for one hour.
- Direct switch control enabling output to be turned on immediately or after a specified time interval.
- 20 function keypad for programme entry.
- Programme verification at the touch of a button.

(Kit includes all components, PCB, assembly and programming instructions).



**NOW ONLY £39
WITH SO MANY
EXTRA FEATURES
OPTIONAL BLACK
PLASTIC CASE.
READY DRILLED
£2.50**

DISCO LIGHTING KITS

DL 2700E

This value-for-money kit features a bi-directional sequence, speed of sequence and frequency of direction change, being variable by means of a potentiometer and incorporates a master dimming control. Only **£14.90**

DL 2700V

A lower cost version of the above, featuring unidirectional channel sequence with speed variable by means of a pre-set pot. Outputs switched only at mains zero crossing points to reduce radio interference to a minimum.

Optional opto input (DA1) allowing audio ("beat") light response. Only **£8.00**



JK102 3-NOTE DOOR CHIME

Based on a simple integrated circuit (SBA0000), this kit comes complete with touchspeaker and drilled box (size: 95 x 71 x 26mm) and requires only a PP3 battery and pushbutton to complete. The unit produces a 3-note harmonically related tone sequence when the pushbutton is operated and may be used to replace any doorbell or switched by logic in such applications as alarms, PA systems and toys. The unit draws less than 1mA from the battery in the standby mode and produces 150mW output which may be readily amplified if a louder sound is required. The small number of components make this an ideal project for beginners. **£5.00**



MEMORIES AND MICROS

2714	2.25	6821P	3.85
2716	2.45	6852P	2.80

PRICES SLASHED

480	8035L	5.50
1215	M802P(CPU)	3.85
1.25	Z80ACPU	3.80
1.60	Z80ACTC	2.80
2.55	Z80AP10	2.80

74 LS TTL

L500	12	L514	48	L542	48	L503	37
L501	12	L515	15	L547	42	L506	48
L502	13	L520	14	L551	15	L5107	24
L503	13	L521	15	L554	15	L5109	24
L504	14	L522	15	L555	15	L5112	24
L505	15	L528	18	L573	20	L5113	24
L508	15	L527	15	L574	18	L5114	24
L509	15	L530	14	L575	27	L5123	51
L510	14	L532	15	L576	21	L5126	28
L511	15	L537	17	L585	44	L5132	44
L512	15	L538	16	L586	18	L5140	40
L513	27	L540	14	L596	32	L5161	46

CMOS

4500	14	4025	18	4081	22
4001	14	4026	1.95	4093	4
4002	14	4027	4.00	4501	24
4003	14	4028	5.00	4511	35
4011	15	4040	3.80	4514	1.90
4012	17	4049	3.00		
4013	35	4050	30		
4015	70	4060	30		
4016	30	4069	1.18		
4017	80	4070	24		
4019	30	4071	22		
4023	32	4077	24		



DVM/ULTRA SENSITIVE THERMOMETER KIT

This new design is based on the ICL7126 in lower power version of the ICL7106 chip and a 3 1/2 digit liquid crystal display. This kit will form the basis of a digital multimeter (only a few additional resistors and switches are required—details supplied), or a sensitive digital thermometer (-50°C to +150°C) reading to 0.1°C. The basic kit has a sensitivity of 200mV for a full scale reading, automatic polarity indication and an ultra low power requirement—giving a 2 year typical battery life from a standard 9V PP3 when used 8 hours a week. **£15.50**



FOR NEW £2 FREE SHORT FORM CATALOGUE SEND SA£ (6" x 9") TODAY

We also stock:

- Vero, Antex Irons,
- Babani Books, Resistors
- Capacitors, & Semi-Conductors Etc.

HOME LIGHTING KITS

These kits contain all necessary components and full instructions & are designed to replace a standard wall switch and control up to 300W of lighting.

TDR300K	Remote Control	£14.30
MES	Dimmer Transmitter for above	£4.20
TDR300K	Touchdimmer	£7.00
TDEK	Extension kit for 2-way switching for TDR300K	£2.00
LDR300K	Rotary Controlled Dimmer	£3.50



REMOTE CONTROL COMPONENTS

LD2718	IR Emitting Diode	£1.30
4802	Photoelectric Detector	3.00
SL486 IC	Pulse Amp	1.70
SL486 Z2	Component	2.40
Encoder/Transmitter		2.40
ML826	10-channel receiver + 3 analog outputs	4.25
ML826	16-channel IR Receiver	2.40
ML826 A	decoder designed for modelkit control, providing 4 speed driver motor and three position steering system or a vehicle with momentary action steering and a third motor, eg. gun turret, winch, etc.	1.80
ML826	also available for other facilities such as horn, fan indicators, headlights	2.50
ML826	16-channel receiver, 4 momentary binary outputs	1.40
ML827	16-channel receiver, 4 momentary binary outputs	1.40
ML828	16-channel receiver, 4 momentary binary outputs	1.40

We have compiled a booklet on remote control, containing circuits, notes, data sheets and a V.A.C. order form. This booklet, kits and components. So don't curtail yourself! Send us your name and a stamped addressed envelope for a free copy of our very new TODAY!

THE KEY TO YOUR SECURITY IS IN OUR LOCK

If the thought of car thieves, house breakers or people tampering with your electrical and electronic equipment upsets you, we have just the kit for you.

Our **ELECTRONIC LOCK KIT** includes 10-way keyboard and a special IC which provides a 720mV output to drive a solenoid or relay (not supplied) when four keys are depressed in the correct sequence. This gives over 5,000 possible combinations! The sequence is prewired and may be easily changed by means of a small plug and socket. A "SAVE" function is also available enabling the open code to be stored (especially useful in a car when it is left in a garage for servicing as the open code need not be disclosed). Size: 7x6x3 cm. Power Consumption is about 100mV 10mA.

At only **£10.50 + VAT**, it will make a smaller hole in your pocket than a bunch of keys!

Electric Lock Mechanism
Suitable for use with existing door locks and above electronic lock kit. **£12.50**

24 HOUR CLOCK/APPLIANCE TIMER KIT

Switches any appliance up to 1kW on and off at present times once per day. Kit contains: AY-5-173D IC, 0.5° LED display, mains supply, display drivers, switches, LEDs, traces, PCBs and full instructions.

CT1000K Basic Kit	£14.90
CT1000K with white box (56-311 x 71mm)	£17.40
(Ready Built)	£22.50

Add 50p postage & packing + 15% VAT to total.

Overseas Customers:
Add £1.50 (Europe), £4.00 (elsewhere) for p&h.
Send S.A.E. for further STOCK DETAILS.
Goods by return subject to availability.

OPEN 9am to 5pm (Mon to Fri)
10am to 4pm (Sat)

FAST SERVICE - TOP QUALITY - LOW LOW PRICES

No circuit is complete without a call to -

ELECTRONICS

Dept. EK
11 Boston Road
London W7 3SJ

ACCESS AND BARGAINERS WELCOME

TEL: 01-567 8910 ORDERS
01-579 2842 TECHNICAL (AFTER 3PM)

ENQUIRIES 01-579 9794



Remember to try us for ALL your component requirements



COMOS		TTL		TTL contd.		TTL LS contd.		OPTO		OPTO contd.		Transistors & Diodes	
4001	13p	7400	11p	74173	60p	74LS162	35p	LEDs	DISPLAYS	IN4001	4p	<p>CAPACITORS Tant Beads 16v .1uf 11p 6.8uf 18p .22uf 11p 10uf 18p .47uf 11p 22uf 30p 1.0uf 11p 15uf 35p 2.2uf 14p 33uf 48p 3.3uf 14p 47uf 80p 4.7uf 18p 68uf 110p</p> <p>Tant Beads 35v .1uf 13p 1.00uf 15p .15uf 13p 1.5uf 15p .22uf 13p 2.2uf 17p .33uf 13p 3.3uf 17p .47uf 13p 4.7uf 20p .68uf 13p 6.8uf 20p 10.0uf 27p</p> <p>Plate Ceramics 63v 10pf 5p 47pf 5p 100pf 5p 220pf 6p 150pf 6p</p> <p>Disc Ceramics .01 50v 2p .1 50v 5p</p> <p>Polystyrene 160v 100pf 9p 2200pf 8p 220pf 9p 3300pf 8p 470pf 9p 4700pf 8p 28p 1000pf 9p 6800pf 8p</p>	
4002	13p	7401	12p	74174	50p	74LS163	35p	0-2"	Bar Graph	IN4002	6p		
4003	60p	7402	12p	74175	50p	74LS164	45p	Red	5"	IN5401	13p		
4004	13p	7403	13p	74180	50p	74LS165	50p	Green	10p	IN5404	16p		
4005	50p	7404	13p	74180	60p	74LS168	60p	Flashing	Common Anode	IN5406	16p		
4006	30p	7405	14p	74191	60p	74LS170	70p	Red	L.H. decimal point	IN4148	3p		
4007	13p	7406	20p	74192	70p	74LS173	40p	Rectangular	Red	IN914	3p		
4008	13p	7407	24p	74193	60p	74LS174	45p	LEDs	Green	IN916	5p		
4009	13p	7408	14p	74194	60p	74LS175	45p	Red	Yellow	BZY88C2V7	8p		
4010	22p	7409	14p	74195	46p	74LS175	45p	Green	Common Cathode	BZY88C3V3	8p		
4011	50p	7410	14p	74196	46p	74LS181	110p	Yellow	R.H. decimal point	BZY88C3V6	8p		
4012	45p	7411	18p	74221	75p	74LS191	45p	Bi-Colour	Red	BZY88C4V7	8p		
4013	25p	7413	22p	74279	40p	74LS192	45p	Red/Green	80p	BZY88C8V8	8p		
4014	48p	7414	26p	74290	60p	74LS193	45p	0-125"	5"	BZY88C8V2	8p		
4015	35p	7416	18p	74298	60p	74LS194	50p	Red	3"	BZY88C12	8p		
4016	48p	7417	22p			74LS196	35p	Green	12p	BC107	11p		
4017	46p	7421	20p			74LS197	50p	Yellow	12p	BC107A/B	11p		
4018	55p	7425	20p			74LS200	70p		Green	BC108A/B/C	11p		
4019	13p	7426	27p	74LS00	12p	74LS241	70p		Red	BC182	9p		
4020	42p	7427	15p	74LS01	12p	74LS244	70p		Green	BC183	9p		
4021	13p	7430	15p	74LS02	12p	74LS245	80p		Yellow	BC184	9p		
4022	26p	7432	18p	74LS03	12p	74LS247	60p			BC212	9p		
4023	40p	7437	18p	74LS04	12p	74LS249	40p			BCY70	17p		
4024	60p	7438	18p	74LS05	12p	74LS251	40p			BCY71	18p		
4025	13p	7439	24p	74LS08	12p	74LS253	35p			BCY72	18p		
4026	55p	7440	16p	74LS09	12p	74LS255	55p			BFY50	28p		
4027	66p	7442	20p	74LS10	13p	74LS256	55p			BFY51	28p		
4028	50p	7445	50p	74LS11	12p	74LS257	40p			BFY52	28p		
4029	50p	7446	68p	74LS13	21p	74LS258	40p			TIP29/A	30p		
4030	46p	7448	55p	74LS14	21p	74LS259	65p			TIP30/A	35p		
4031	50p	7450	15p	74LS15	21p	74LS260	30p			TIP31/A	45p		
4032	20p	7451	15p	74LS20	12p	74LS266	22p			TIP32/A	45p		
4033	20p	7453	15p	74LS26	12p	74LS273	60p			TIP/41A	50p		
4034	50p	7454	15p	74LS27	12p	74LS279	40p			TIP42/A	50p		
4035	60p	7470	30p	74LS28	22p	74LS283	40p			2N708	24p		
4036	50p	7472	25p	74LS30	12p	74LS290	34p			2N918	26p		
4037	28p	7474	22p	74LS33	14p	74LS293	34p			2N2218/A	28p		
4038	44.7p	7475	23p	74LS37	19p	74LS295	52p			2N2219/A	28p		
4039	13p	7476	22p	74LS38	12p	74LS299	83p			2N2221/A	24p		
4040	13p	7483	47p	74LS40	19p	74LS322	90p			2N2904/A	28p		
4041	13p	7485	60p	74LS42	40p	74LS323	130p			2N2905A	28p		
4042	13p	7486	25p	74LS47	44p	74LS374	55p			2N2906A	28p		
4043	50p	7490	26p	74LS48	44p	74LS375	40p			2N3053	28p		
4044	13p	7491	45p	74LS51	12p	74LS375	40p			2N3055	46p		
4045	45p	7492	38p	74LS54	12p	74LS377	70p			2N3442	13p		
4046	30p	7493	28p	74LS74	18p	74LS378	60p			2N3715	57p		
4047	30p	7495	50p	74LS83	42p	74LS379	60p			2N3716	65p		
4048	30p	7496	45p	74LS86	14p	74LS379	60p						
4049	42p	74107	25p	74LS90	30p	74LS379	60p						
4050	52p	74121	20p	74LS92	30p	74LS379	60p						
4051	45p	74122	35p	74LS93	30p	74LS379	60p						
4052	50p	74123	40p	74LS95	40p	74LS379	60p						
4053	60p	74125	38p	74LS109	40p	74LS379	60p						
4054	40p	74126	38p	74LS112	30p	74LS379	60p						
4055	60p	74145	50p	74LS126	28p	74LS379	60p						
4056	60p	74150	90p	74LS128	28p	74LS379	60p						
4057	64p	74151	40p	74LS132	40p	74LS379	60p						
4058	64p	74153	45p	74LS133	25p	74LS379	60p						
4059	45p	74154	75p	74LS136	20p	74LS379	60p						
4060	45p	74155	45p	74LS138	30p	74LS379	60p						
4061	50p	74157	35p	74LS139	30p	74LS379	60p						
4062	30p	74158	30p	74LS151	40p	74LS379	60p						
4063	60p	74161	45p	74LS153	40p	74LS379	60p						
4064	60p	74163	45p	74LS155	45p	74LS379	60p						
4065	55p	74164	60p	74LS156	45p	74LS379	60p						
4066	55p	74165	65p	74LS157	30p	74LS379	60p						
4067	55p	74166	70p	74LS158	30p	74LS379	60p						
4068	60p	74167	120p	74LS160	35p	74LS379	60p						
4069	60p	74170	120p	74LS161	35p	74LS379	60p						

PHONE US TO CHECK AVAILABILITY OF COMPONENTS MENTIONED IN THIS ISSUE

Thames Valley

24 High Street Burnham-Bucks

Electronics Ltd

Telephone Burnham (06286) 6582

BARGAIN OFFER
2732 250ms
1 off 520p
10 off 470p

Please add VAT at 15%
Plus Postage & Packing 45p
Government and Educational establishments orders accepted.

Make it with MAPLIN



KEYBOARD WITH ELECTRONICS FOR ZX81

- * A full size, full travel 43 key keyboard that's simple to add to your ZX81 (no soldering in ZX81).
- * Complete with the electronics to make "Shift Lock", "Function" and "Graphics 2" single key selections making entry far easier.
- * Powered from ZX81's own standard power supply - with special adaptor supplied.
- * Two-colour print for key caps.
- * Amazing low price.

Full details in our projects book. Price 60p.
Order As XA03D

Complete kit for only £19.95 incl. VAT and carriage.
Order As LW72P

25W STEREO MOSFET AMPLIFIER



A superb new amplifier at a remarkably low price.

- * Over 25W per channel into 8Ω at 1kHz both channels driven.
- * Frequency response 20Hz to 40kHz \pm 1dB.
- * Low distortion, low noise and high reliability power MOSFET output stage.
- * Extremely easy to build. Almost everything fits on main pcb, cutting interwiring to just 7 wires (plus toroidal transformer and mains lead terminations).
- * Complete kit contains everything you need including pre-drilled and printed chassis and wooden cabinet.

Full details in our projects book. Price 60p.
Order As XA03D

Complete kit for only £49.95 incl. VAT and carriage.
Order As LW71N

MATINÉE ORGAN

Easy to build, superb specification.
Comparable with organs selling for up to £1,000. Full construction details in our book. Price £2.50.
Order As XH55K.
Complete kits available:
Electronics - £299.95,
Cabinet - £99.50 (carriage extra).
Demo cassette price £1.99. Order As XX43W.



HOME SECURITY SYSTEM



Six independent channels - 2 or 4 wire operation. External horn. High degree of protection and long term reliability. Full details in our projects book.
Price 60p.
Order As XA02C.



DIGITAL MULTI-TRAIN CONTROLLER

Control up to 14 trains individually on the same track with any four simultaneously! Low cost kits available. Full details in our projects book. Price 60p.
Order As XA02C.

MILES PER GALLON METER

Digital display shows you how economical your driving is as you go along.
Complete kits available.
Full details in our projects book.
Price 60p.
Order As XA02C.



Don't miss out - get a copy of our catalogue now!
Over 140,000 copies sold already!

(In sale now in all branches of WHSMITH ☺ Price £1.

320 big pages packed with data and pictures of over 5,500 items.



Post this coupon now!

Please send me a copy of your 320 page catalogue. I enclose £1.25 (inc. 25p p&ph). If I am not completely satisfied I may return the catalogue to you and have my money refunded.

If you live outside the U.K. send £1.68 or 12 International Reply Coupons.

Name

Address

E782

MAPLIN

ELECTRONIC
SUPPLIES LTD.

All mail to:

P.O. Box 3, Rayleigh, Essex S56 8LR
Tel: Sales (0702) 552911 General (0702) 554155

Shops at:

159 King St., Hammersmith, London W6. Tel: 01-748 0926
284 London Rd., Westcliff-on-Sea, Essex. Tel: (0702) 554000
Note: Shops closed Mondays